

Aspire 1820TP/1420P Series

Service Guide

Service guide files and updates are available on the ACER/CSD web; for more information, please refer to <http://csd.acer.com.tw>

Revision History

Please refer to the table below for the updates made on this service guide.

Date	Chapter	Updates

Copyright

Copyright © 2009 by Acer Incorporated. All rights reserved. No part of this publication may be reproduced, transmitted, transcribed, stored in a retrieval system, or translated into any language or computer language, in any form or by any means, electronic, mechanical, magnetic, optical, chemical, manual or otherwise, without the prior written permission of Acer Incorporated.

Disclaimer

The information in this guide is subject to change without notice.

Acer Incorporated makes no representations or warranties, either expressed or implied, with respect to the contents hereof and specifically disclaims any warranties of merchantability or fitness for any particular purpose. Any Acer Incorporated software described in this manual is sold or licensed "as is". Should the programs prove defective following their purchase, the buyer (and not Acer Incorporated, its distributor, or its dealer) assumes the entire cost of all necessary servicing, repair, and any incidental or consequential damages resulting from any defect in the software.

Acer is a registered trademark of Acer Corporation.

Intel is a registered trademark of Intel Corporation.

Pentium and Pentium II/III are trademarks of Intel Corporation.

Other brand and product names are trademarks and/or registered trademarks of their respective holders.

Conventions

The following conventions are used in this manual:

SCREEN MESSAGES	Denotes actual messages that appear on screen.
NOTE	Gives bits and pieces of additional information related to the current topic.
WARNING	Alerts you to any damage that might result from doing or not doing specific actions.
CAUTION	Gives precautionary measures to avoid possible hardware or software problems.
IMPORTANT	Reminds you to do specific actions relevant to the accomplishment of procedures.

Preface

Before using this information and the product it supports, please read the following general information.

1. This Service Guide provides you with all technical information relating to the BASIC CONFIGURATION decided for Acer's "global" product offering. To better fit local market requirements and enhance product competitiveness, your regional office MAY have decided to extend the functionality of a machine (e.g. add-on card, modem, or extra memory capability). These LOCALIZED FEATURES will NOT be covered in this generic service guide. In such cases, please contact your regional offices or the responsible personnel/channel to provide you with further technical details.
2. Please note WHEN ORDERING FRU PARTS, that you should check the most up-to-date information available on your regional web or channel. If, for whatever reason, a part number change is made, it will not be noted in the printed Service Guide. For ACER-AUTHORIZED SERVICE PROVIDERS, your Acer office may have a DIFFERENT part number code to those given in the FRU list of this printed Service Guide. You MUST use the list provided by your regional Acer office to order FRU parts for repair and service of customer machines.

System Specifications	1
Features	1
System Block Diagram	3
Your Notebook Tour	4
Front View	4
Closed Front View	5
Left View	6
Right View	6
Base View	7
Rear View	8
Indicators	8
TouchPad Basics	9
Using the Keyboard	10
Lock Keys and embedded numeric keypad	10
Windows Keys	11
Hot Keys	12
Special Keys	13
Hardware Specifications and Configurations	14
 System Utilities	 23
BIOS Setup Utility	23
Navigating the BIOS Utility	23
Information	24
Main	25
Security	26
Boot	29
Exit	30
BIOS Flash Utility	31
DOS Flash Utility	32
WinFlash Utility	33
Remove HDD/BIOS Password Utilities	34
Removing BIOS Passwords:	35
Miscellaneous Utilities	36
 Machine Disassembly and Replacement	 39
Disassembly Requirements	39
Related Information	39
General Information	39
Pre-disassembly Instructions	39
Disassembly Process	40
External Module Disassembly Process	41
External Modules Disassembly Flowchart	41
Removing the Dummy Card	42
Removing the Battery Pack	42
Removing the SIM Card	43
Removing the Module Cover	44
Removing the Hard Disk Drive Module	45
Removing the DIMM Module	47
Removing the WLAN Board	48
Removing the 3G Module	49
Main Unit Disassembly Process	51
Main Unit Disassembly Flowchart	51
Removing the Keyboard	53
Removing the Hinge Covers	55

Table of Contents

Removing the Upper Cover	57
Removing the Button Board	61
Removing the I/O Board	65
Removing the Bluetooth Module	67
Removing the LED Board	68
Removing the CRT Board	71
Removing the Mainboard	73
Removing the Thermal Module	76
Removing the RTC Battery	77
Removing the Speaker Modules	77
Removing the LCD Module	78
LCD Module Disassembly Process	80
LCD Module Disassembly Flowchart	80
Removing the LCD Bezel	82
Removing the Camera Board	85
Removing the Microphone	86
Removing the LCD Panel	86
Removing the LCD Cable	88
Removing the LCD Brackets	91
Removing the Touchscreen Board	92
Removing the Hinge	93
Removing the Antennas	94
LCD Reassembly Procedure	97
Replacing the Antennas	97
Replacing the Hinge	98
Replacing the Touchscreen Board	99
Replacing the LCD Brackets	100
Replacing the LCD Cable	101
Replacing the LCD Panel	103
Replacing the Microphone	105
Replacing the Camera Board	106
Replacing the LCD Bezel	107
Main Unit Reassembly Process	110
Replacing the LCD Module	110
Replacing the RTC Battery	112
Replacing the Thermal Module	112
Replacing the Speakers	113
Replacing the Mainboard	115
Replacing the CRT Board	117
Replacing the LED Board	118
Replacing the Bluetooth Module	121
Replacing the I/O Board	122
Replacing the Button Board	125
Replacing the Upper Cover	128
Replacing the Hinge Covers	131
Replacing the Keyboard	133
Replacing the 3G Module	134
Replacing the WLAN Module	136
Replacing the DIMM	137
Replacing the Hard Disk Drive	137
Replacing the Module Cover	139
Replacing the SIM Card	141
Replacing the Battery	141
Replacing the Dummy Card	142

Troubleshooting	143
Common Problems	143
Power On Issue	144
No Display Issue	145
Random Loss of BIOS Settings	146
LCD Failure	147
Built-In Keyboard Failure	148
TouchPad Failure	149
Internal Speaker Failure	150
Internal Microphone Failure	151
HDD Not Operating Correctly	152
USB Failure (Right up/down side)	153
Other Failures	153
Intermittent Problems	154
Undetermined Problems	154
Post Codes	155
Jumper and Connector Locations	165
Mainboard Top View	165
Mainboard Bottom View	166
Clearing Password Check and BIOS Recovery	167
Mainboard CMOS Discharge	167
BIOS Recovery by Crisis Disk	168
FRU (Field Replaceable Unit) List	169
Exploded Diagram	169
Fru List	171
Model Definition and Configuration	177
Test Compatible Components	191
MS Compatibility Test Report	194
Online Support Information	199
Index	201

Table of Contents

System Specifications

Features

Below is a brief summary of the computer's many features:

Operating System

- Genuine Windows® 7

Platform

- Intel® Core™2 Duo processor*
- Intel® Pentium® mobile processor*
- Intel® Celeron® mobile processor*
- Mobile Intel® GS45 Express Chipset

System Memory

- Dual-Channel SDRAM support
- Up to 4 GB of DDR3 1066 MHz memory, upgradeable to 8 GB using two soDIMM modules

Display and graphics

- 11.6" HD 1366 x 768
- Convertible display
- Mobile Intel® GS45 Express Chipset

Storage subsystem

- 2.5" hard disk drive
- Multi-in-1 card reader

Audio subsystem

- Optimized 2nd Generation Dolby® Sound Room® audio enhancement
- High-definition audio support
- S/PDIF (Sony/Philips Digital Interface) support for digital speakers
- MS-Sound compatible
- Built-in microphone

Communication

- Integrated Acer Crystal Eye webcam*
- WWAN: UMTS/HSPA at 850/900/1900/2100 MHz and quad-band GSM/GPRS/EDGE (850/900/1800/1900 MHz)*

-
- WLAN:
 - Intel® WiFi Link 5100 802.11a/b/g/Draft-N*
 - Intel® WiFi Link 5100 802.11a/b/g*
 - Intel® WiFi Link 1000*
 - WPAN: Bluetooth® 2.1+Enhanced Data Rate*
 - LAN: Gigabit Ethernet; Wake-on-LAN ready

Privacy control

- BIOS user, supervisor, HDD passwords
- Kensington lock slot

Dimensions and Weight

- 285 (W) 208.9 (D) 28.5/34.5 (H) mm (11.22 x 8.22 x 1.12/1.36 inches)
- 1.72 kg (3.79 lbs.) (non-3G SKU)

Power subsystem

- ACPI 3.0
- 62.16 W 5600 mAh
- 3-pin 30 W AC adapter
- ENERGY STAR®*

Special keys and controls

- 84-/85-/88-key keyboard
- Multi-gesture touchpad pointing device

I/O interface

- Multi-in-1 card reader (SD/MMC/MS/MS PRO/xD)
- USB 2.0 port
- HDMI™ port with HDCP support
- External display (VGA) port
- Headphones/speaker/line-out jack with S/PDIF support
- Microphone-in jack
- Ethernet (RJ-45) port
- DC-in jack for AC adapter

Environment

- Temperature:
 - Operating: 5 °C to 35 °C
 - Non-operating: -20 °C to 65 °C
- Humidity (non-condensing):
 - Operating: 20% to 80%
 - Non-operating: 20% to 80%

NOTE: The specifications listed above are for reference only. The exact configuration of the PC depends on the model purchased.

System Block Diagram

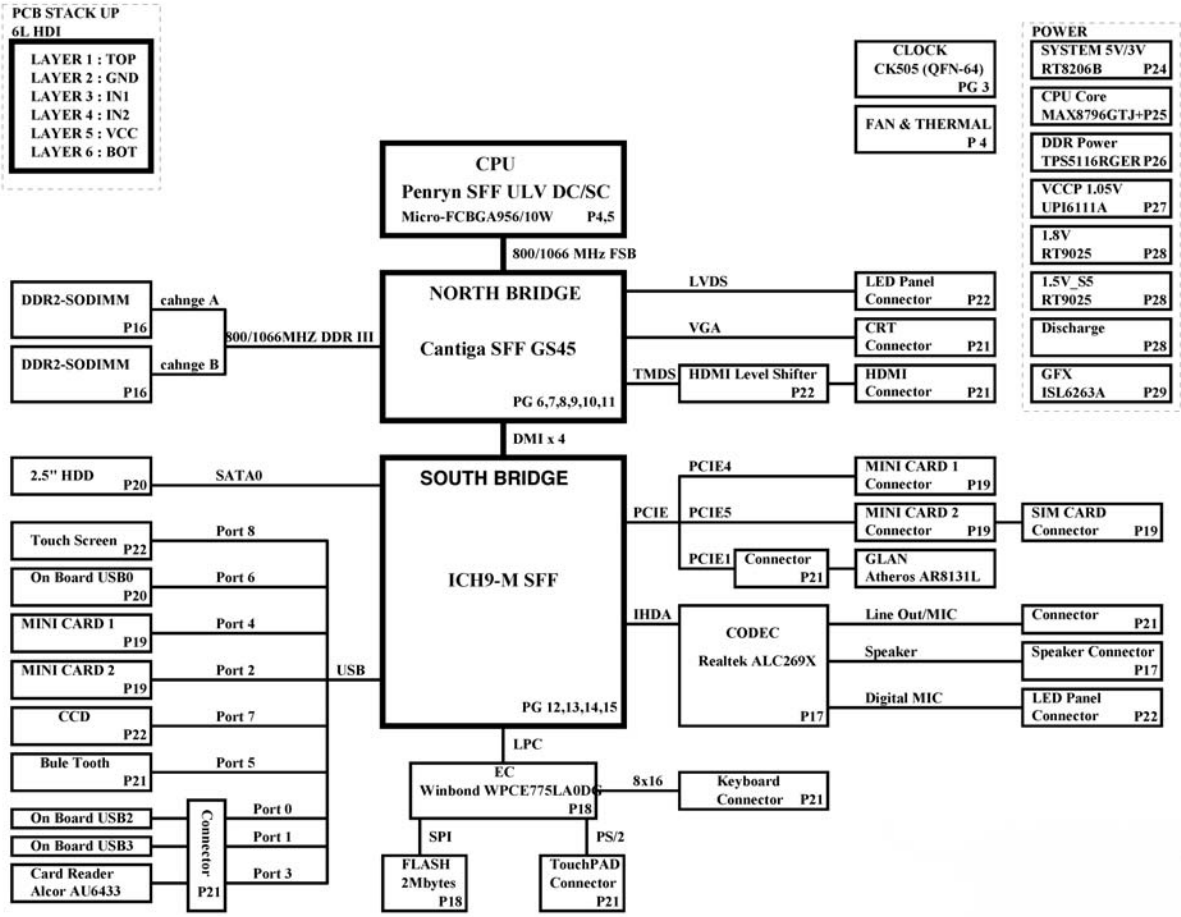



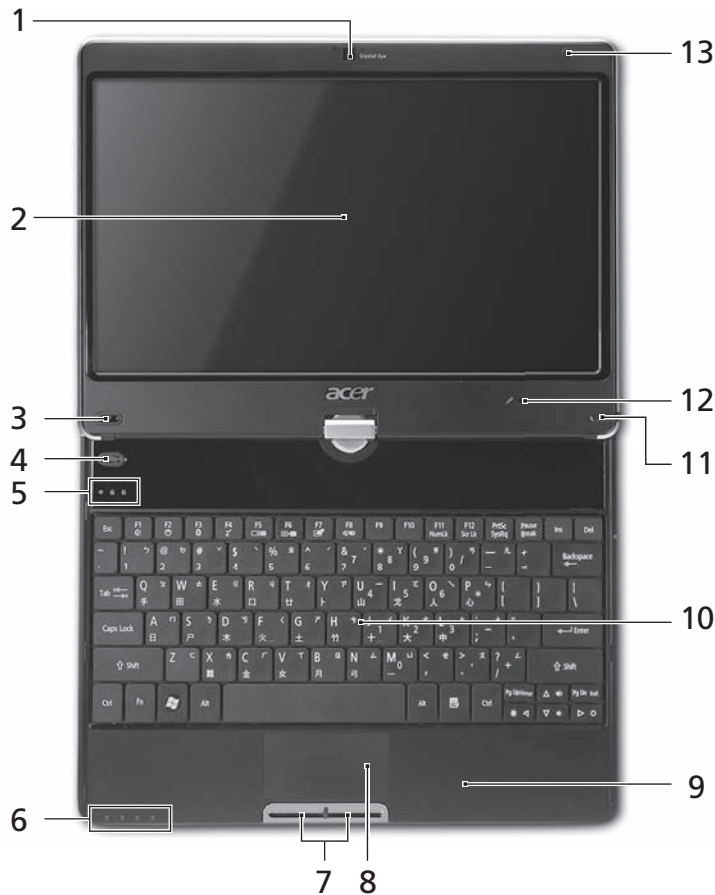

Your Notebook Tour

This section provides an overview of the features and functions of the notebook.

Front View



No.	Icon	Item	Description
1		Acer Crystal Eye webcam	Web camera for video communication
2		Display screen	Also called Liquid-Crystal Display (LCD), displays computer output (Configuration may vary by models).
3	P	Programmable key	Launch predefined programs or user defined programs at the push of a button.
4		Backup key	Press to start automatic backup procedure.
5		HDD	Indicates when the hard drive is active.
		Num Lock	Lights up when the Num Lock is activated.
		Caps Lock	Lights up when Caps Lock is activated.

No.	Icon	Item	Description
6		Power	Indicated the computer's power status.
		Battery	Indicates the computer's battery status. 1. Charging: The light shows amber when the battery is charging. 2. Fully charged: The light shows blue when in AC mode.
		Bluetooth communication indicator	Indicates the status of Bluetooth communication. (only for certain models)
		Communication indicator	Indicates the status of WLAN / 3G communication.
7		Click buttons (left and right)	The left and right buttons function like the left and right mouse buttons.
8		Touchpad	Touch-sensitive pointing device which functions like a computer mouse.
9		Palmrest	Comfortable support area for your hands when you use the computer.
10		Keyboard	For entering data into your computer.
11		Stylus	A pen tool for entering data into your computer
12		Microphone	Internal microphone for sound recording
13		Magnetic lock	A lock that snaps into place to prevent the screen from inadvertently rotating.

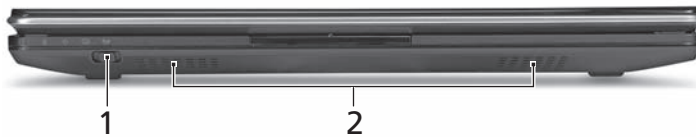

Closed Front View



No.	Icon	Item	Description
1		Communication key	Enables / disables the WLAN / 3G functions.
2		Speakers	Left and right speakers deliver stereo audio output.

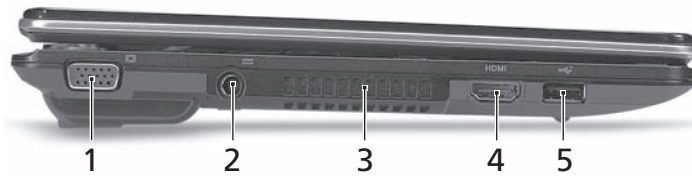



Left View



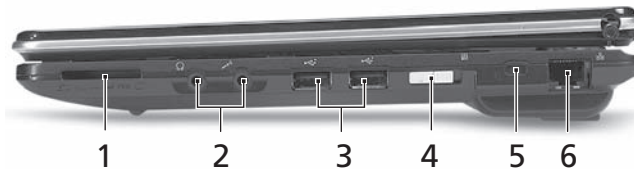

No.	Icon	Item	Description
1		External display (VGA) port	Connects to a display device (e.g. external monitor, LCD projector).
2		DC-in jack	Connects to an AC adapter
3		Ventilation slots	Enable the computer to stay cool, even after prolonged use.
4	HDMI	HDMI port	Supports high definition digital video connections.
5		USB 2.0 port	Connect to USB 2.0 devices (e.g., USB mouse, USB camera).

Right View







No.	Icon	Item	Description
1		Multi-in-1 card reader	Accepts Secure Digital (SD), MultiMediaCard (MMC), Memory Stick (MS), Memory Stick PRO (MS PRO), xD-Picture Card (xD). Note: Push to remove/install the card. Only one card can operate at any given time.
2		Headphones/speaker/line-out jack with S/PDIF support	Connects to audio line-out devices (e.g., speakers, headphones).
		Microphone-in jack	Accepts inputs from external microphones.
3		USB 2.0 port	Connects to USB 2.0 devices (e.g., USB mouse, USB camera).
4		Power button / indicator	Slide the power button to turn the computer on and off. / Indicates the computer's power status.

5		Kensington lock slot	Connects to a Kensington-compatible computer security lock. Note: Wrap the computer security lock cable around an immovable object such as a table or handle of a locked drawer. Insert the lock into the notch and turn the key to secure the lock. Some keyless models are also available.
6		Ethernet (RJ-45) port	Connects to an Ethernet 10/100/1000-based network.

Base View



No.	Icon	Item	Description
1		Battery bay	Houses the computer's battery pack.
2		Hard disk bay	Houses the computer's hard disk (secured with screws).
3		Memory compartment	Houses the computer's main memory.
4		Ventilation slots and cooling fan	Enable the computer to stay cool, even after prolonged use. Note: Do not cover or obstruct the opening of the fan.
5		Battery lock	Locks the battery in position.
6		Battery release latch	Releases the battery for removal.



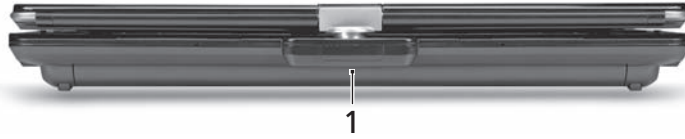



Rear View



No.	Icon	Item	Description
1		Battery bay	Houses the computer's battery pack.

Indicators

The computer has several easy-to-read status indicators. The battery indicator is visible even when the computer cover is closed.

Icon	Function	Description
	Bluetooth	Indicates the status of Bluetooth communication.
	Wireless LAN	Indicates the status of Wireless LAN/3G communication.
	HDD	Indicates when the hard disk drive is active.
	Num Lock	Lights up when Num Lock is activated.
	Caps Lock	Lights up when Caps Lock is activated.
	Battery	Indicates the computer's battery status.

NOTE: 1. **Charging:** The battery light shows amber when the battery is charging. 2. **Fully charged:** The light shows green when in AC mode.

TouchPad Basics

The following items show you how to use the TouchPad:

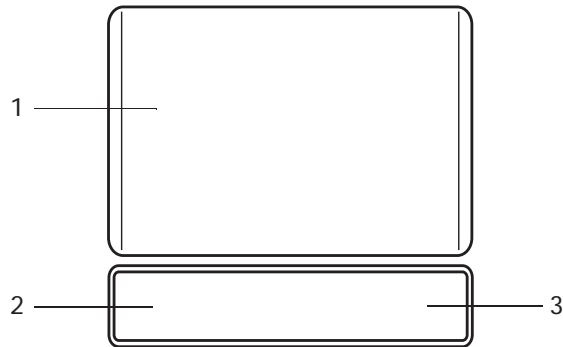

- Move your finger across the TouchPad (1) to move the cursor.
- Press the left (2) and right (3) buttons located beneath the TouchPad to perform selection and execution functions. These two buttons are similar to the left and right buttons on a mouse. Tapping on the TouchPad is the same as clicking the left button.

Function	Left Button (2)	Right Button (3)	Main TouchPad (1)
Execute	Quickly click twice.		Tap twice (at the same speed as double-clicking a mouse button).
Select	Click once.		Tap once.
Drag	Click and hold, then use finger on the TouchPad to drag the cursor.		Tap twice (at the same speed as double-clicking a mouse button); rest your finger on the TouchPad on the second tap and drag the cursor.
Access context menu		Click once.	

NOTE: When using the TouchPad, keep it - and your fingers - dry and clean. The TouchPad is sensitive to finger movement; hence, the lighter the touch, the better the response. Tapping too hard will not increase the TouchPad's responsiveness.

Using the Keyboard

This computer has a close-to-full-sized keyboard and an embedded numeric keypad, separate cursor, lock, function and special keys.

Lock Keys and embedded numeric keypad

The keyboard has three lock keys which you can toggle on and off.













Lock key	Description
Caps Lock	When Caps Lock is on, all alphabetic characters typed are in uppercase.
Num Lock <Fn> + <F11>	When Num Lock is on, the embedded keypad is in numeric mode. The keys function as a calculator (complete with the arithmetic operators +, -, *, and /). Use this mode when you need to do a lot of numeric data entry. A better solution would be to connect an external keypad.
Scroll Lock <Fn> + <F12>	When Scroll Lock is on, the screen moves one line up or down when you press the up or down arrow keys respectively. Scroll Lock does not work with some applications.

The embedded numeric keypad functions like a desktop numeric keypad. It is indicated by small characters located on the upper right corner of the keycaps. To simplify the keyboard legend, cursor-control key symbols are not printed on the keys.

Desired access	Num Lock on	Num Lock off
Number keys on embedded keypad	Type numbers in a normal manner.	
Cursor-control keys on embedded keypad	Hold <Shift> while using cursor-control keys.	Hold <Fn> while using cursor-control keys.
Main keyboard keys	Hold <Fn> while typing letters on embedded keypad.	Type the letters in a normal manner.

Windows Keys













The keyboard has two keys that perform Windows-specific functions.

Key	Description
 Windows key	<p>Pressed alone, this key has the same effect as clicking on the Windows Start button; it launches the Start menu. It can also be used with other keys to provide a variety of functions:</p> <ul style="list-style-type: none"><  >: Open or close the Start menu<  > + <D>: Display the desktop<  > + <E>: Open Windows Explore<  > + <F>: Search for a file or folder<  > + <L>: Lock your computer (if you are connected to a network domain), or switch users (if you're not connected to a network domain)<  > + <M>: Minimizes all windows<  > + <R>: Open the Run dialog box<  > + <U>: Open Ease of Access Center<  > + <BREAK>: Display the System Properties dialog box<  > + <TAB>: Cycle through programs on the taskbar<CTRL> + <  > + <F>: Search for computers (if you are on a network) <p>Note: Depending on your edition of Windows 7, some shortcuts may not function as described.</p>
 Application key	This key has the same effect as clicking the right mouse button; it opens the application's context menu.

Hot Keys

The computer employs hotkeys or key combinations to access most of the computer's controls like screen brightness and volume output.

To activate hotkeys, press and hold the <Fn> key before pressing the other key in the hotkey combination.

Hotkey	Icon	Function	Description
<Fn> + <F1>		Power management	Launch Windows power management.
<Fn> + <F2>		System Properties	Display the System Properties dialog box.
<Fn> + <F3>		Bluetooth communication switch	Enables/disables the Bluetooth function.
<Fn> + <F4>		Sleep	Puts the computer in Sleep mode.
<Fn> + <F5>		Display toggle	Switches display output between the display screen, external monitor (if connected) and both.
<Fn> + <F6>		Screen blank	Turns the display screen backlight off to save power. Press any key to return.
<Fn> + <F7>		Touchpad toggle	Turns the internal touchpad on and off.
<Fn> + <F8>		Speaker toggle	Turns the speakers on and off.
<Fn> + <▷>		Brightness up	Increases the screen brightness.
<Fn> + <◁>		Brightness down	Decreases the screen brightness.
<Fn> + <△>		Volume up	Increases the sound volume.
<Fn> + <▽>		Volume down	Decreases the sound volume.

Special Keys

You can locate the Euro symbol and the US dollar sign at the upper-center and/or bottom-right of your keyboard.

The Euro symbol

1. Open a text editor or word processor.
2. Hold <Alt Gr> and then press the <5> key at the upper-center of the keyboard.

NOTE: Some fonts and software do not support the Euro symbol. See www.microsoft.com/typography/faq/faq12.htm for more information.

The US dollar sign

1. Open a text editor or word processor.
2. Hold <Shift> and then press the <4> key at the upper-center of the keyboard.

NOTE: This function varies according to the language settings.

Hardware Specifications and Configurations

Processor

Item	Specification
CPU type	Intel Penryn SFF (ULV)
CPU package	Micro-FCBGA 956 balls
Features	<ul style="list-style-type: none"> • Supports Intel architecture with Dynamic execution. • On-die, primary 32-kB instruction cache and 32-kB write-back data cache. • On-die, up to 3MB second level shared cache with advanced transfer cache architecture. • Streaming SIMD Extensions 2 (SSE2), Streaming SIMD Extensions 3 (SSE3) • Supplemental streaming SIMD extensions 3 (SSSE3) and SSE4.1 instruction sets. • 800MHz source-synchronous front side bus (FSB) • Advanced power management features including Enhanced Intel SpeedStep® • Technology and dynamic FSB frequency switching. • Digital thermal sensor (DTS). • Execute disable bit support for enhanced security. • Intel® Dynamic Acceleration Technology and Enhanced Multi Threaded • Thermal Management (EmTTM). • Support enhanced Intel Virtualization Technology.
Core Logic	• Mobile Intel® GS45 Express Chipset

Processor Specifications

Item	CPU Speed	Cores	Cache Size	Package	Core Voltage	Acer P/N
SU7300	1.4GHz	1	3MB	Micro-FCBGA 956 balls	1.050V-1.150V	C2DSU7300B
SU4100	1.3GHz	2	2MB	Micro-FCBGA 956 balls	1.050V-1.150V	PMDSU4100B
SU2300	1.2GHz	2	1MB	Micro-FCBGA 956 balls	1.050V-1.150V	CMSU2300B

CPU Fan True Value Table

CPU Temperature (Celsius)	Fan Speed (RPM)	SPL Spec (dBA)
38	2400	On
43	3300	26
49	4000	29
56	4500	31

Throttling 50%: On = 88°C; Off = 85°C

EC shut down at 95°C; H/W shut down at 98°C

North Bridge Specifications

Item	Specification
Chipset	Intel Crestline GS45 SFF
Package	FCBGA 1363 balls

Item	Specification
Features	<ul style="list-style-type: none"> Processor host bus supports 667/800/1066Mhz FSB support. Supports Dual Channel DDR3 SD-RAM at 800/1066MHz. Integrated SDRAM controller up to *GB (2 SODIMM support) DMI x2 and DMI x4 for connection between GMCH and ICH9M.

South Bridge Specifications

Item	Specification
Chipset	ICH9M SFF
Package	BGA 676 balls
Features	<ul style="list-style-type: none"> Upstream accelerated Hub architecture interface for access to GMCH. PCI Express Base Specification, Revision 1.1 support. PCI 2.3 interface. (4 PCI Request/Grant pairs). ACPI Power Management Logic Support. Enhanced DMA controller, interrupt controller, timers functions. Integrated Serial ATA host controllers with independent DMA operation on six ports and AHCI support. USB 1.1 & USB 2.0 Host controllers. Supports Intel High Definition Audio (Intel HD Audio) Interface. Supports Intel® Matrix Storage Technology. Supports Intel® Active Management Technology. Low Pin Count (LPC) interface. 6 PCIe ports.

System Memory

Item	Specification
Memory size	0MB (No on-board Memory)
DIMM socket number	2 sockets
Supports memory size per socket	2GB
Supports maximum memory size	4GB for 64bit OS (with two 2GB SO-DIMM)
Supports DIMM type	DDR3 Synchronous DRAM
Supports DIMM Speed	800 MHz
Supports DIMM voltage	1.5V
Supports DIMM package	204-pin DDR3-800 SO-DIMM
Module Combination	Any combination permissible within the above specifications.

Hard Disk Drive Interface

Item	Specifications					
Vendor & Model Name	Hitachi HTS545050B 9A300	Hitachi HTS545032B 9A300	Hitachi HTS545025B 9A300	Hitachi HTS545016B 9A300	Hitachi HTS543225L 9A300	Hitachi HTS543216L9 SA00
Capacity (GB)	500	320	250	160	250	160
Bytes per sector	512					
Data heads	4	3	2	2	3	2
Drive Format						

Item	Specifications					
Disks	2	2	1	1	2	1
Spindle speed (RPM)	5400					
Performance Specifications						
Buffer size	8MB					
Interface	SATA					
Internal transfer rate (Gbits/sec., max)	3GB/s maximum					1.5GB/s maximum
I/O data transfer rate (Mbytes/sec max)	875 Mbits/s maximum		845 Mbits/s maximum	775Mbits/s maximum	729Mbits/s maximum	
DC Power Requirements						
Voltage	+5.0V ± 5%.					

Item	Specifications			
Vendor & Model Name	Toshiba MK1655GSX	Toshiba MK2555GSX	Toshiba MK3255GSX	Toshiba MK5055GSX
Capacity (GB)	160	250	320	500
Bytes per sector	512	512	512	512
Data heads	2	2	4	4
Drive Format				
Disks	1	1	2	2
Spindle speed (RPM)	5400			
Performance Specifications				
Buffer size	8MB			
Interface	SATA			
Internal transfer rate (Mbits/sec, max)	363 – 952 typical			
I/O data transfer rate (Mbytes/sec max)	300			
DC Power Requirements				
Voltage	5V ±5%			

Item	Specifications			
Vendor & Model Name	Western Digital WD1600BEVT-22ZCT0	Western Digital WD2500BEVT-22ZCT0	Western Digital WD3200BEVT-22ZCT0	Western Digital WD5000BEVT-22ZAT0
Capacity (GB)	160	250	320	500
Bytes per sector	512			
Data heads	2	4	3	4

Item	Specifications			
Drive Format				
Disks	1	2	2	2
Spindle speed (RPM)	5400			
Performance Specifications				
Buffer size	8 MB			
Interface	SATA			
Internal transfer rate (Mbits/sec, max)	N/A			
I/O data transfer rate (Mbytes/sec max)	300			
DC Power Requirements				
Voltage	5V ±5%			

BIOS

Item	Specification
BIOS vendor	Insyde
BIOS ROM type	W25X16AVSSIG
BIOS ROM size	16Mb
BIOS package	8 PIN SOIC
Supported Protocols	SPI
BIOS password control	Set by setup manual

LCD 11.6"

Item	Specifications			
Vendor/model name	AUO B116XW02	Chi Mei N116B6-L02	LG LP116WH1	Samsung LTN116AT01-A01
Screen Diagonal (mm)	293.83			
Active Area (mm)	256.125 (H) x 144.00 (V)			
Display resolution (pixels)	1366x3(RGB) x 768			
Pixel Pitch (mm)	0.1875 x 0.1875			0.2265(H) x 0.2265(V)
Typical White Luminance (cd/m ²) also called Brightness	200 typ. (5 points average)			
Contrast Ratio	500:1 typ			
Response Time (Optical Rise Time/Fall Time) msec	8 typ / 16 Max	8 typ / 16 Max	9 typ / 16 max	16 typ / 25 max
Typical Power Consumption (watt)	4.0 max. (Include Logic and Blu power)	N/A	3.18 W Typ.	N/A
Weight (without inverter)	255g max.	240g max	255g max.	
Physical Size (mm)	268L x 161.5W x 5.0T			

Item	Specifications			
Electrical Interface	1 channel LVDS	3.3V LVDS	LVDS	LVDS
Viewing Angle (degree)				
Horizontal (Right) / (Left)	45/45	45/45	30/30	45/45
Vertical (Upper) / (Lower)	10/30	20/45	10/20	15/35

Bluetooth

Item	Specification
Bluetooth Controller	Foxconn T60H928.33
Features	<ul style="list-style-type: none"> Fully Qualified Bluetooth v2.1 with Class 2 specification RF output power. Enhanced Data Rate (EDR) compliant. Full Piconet and Scatternet operation. Integrated PIFA Antenna with better RF performance. USB 2.0 compliant interface. F/W upgradable via Flash downloads. Very low power consumption. Support Coexistence with Intel WCS (Wireless Coexistence System) & AFH (Adaptive Frequency Hopping)
Radio Technology	FHSS
Operating Frequency	2.402GHz ~ 2.480GHz
Channel Numbers	79 channels with 1MHz BW
Transmitter Output Power	-6~4dBm output power for BT class 2 operation
Coverage	10m (Varies depending on operating environment)
Receiver Sensitivity	-75dBm, BER<0.1%
Maximum Receiver Signal	-10dBm
Operating Voltage	3.3V+/-0.3V
Working Temperature	Operating temp: 0 °C to +70 °C (+32 °F to +158 °F) Non-operating temp: -10 °C to +75°C (+14 °F to +167 °F)
Interface	USB2.0 with JST SM08B-SURS-TF connector
Weight	1.75g

Audio Interface

Item	Specification
Codec Controller	Realtek ALC269X
Compatibility	<ul style="list-style-type: none"> Headphone-out S/PDIF, Line-In and Microphone-In. 2 stereo ADCs support 16/20/24-bit PCM format recording simultaneously.
Sampling Rate	<ul style="list-style-type: none"> All DACs supports 16/20/24-bit, 44.1k/48k/96k/192kHz sample rate. Two independent S/PDIF-OUT converters support 16/20/24-bit, 44.1k/48k/88.2k/96k/192kHz sample rate. One for normal S/PDIF output, the other one output an independent digital stream to HDMI transmitter.
Internal Microphone	<ul style="list-style-type: none"> Digital MICRO PHONE ZK2(HFM-M101-006-L19-G) Digital MICRO PHONE ZK2(A-OA2408FM-018)
Internal Speakers	<ul style="list-style-type: none"> Two Med-High Speakers (1W/4Ü)

LAN Interface

Item	Specification
LAN Chipset	Atheros AR8131L
Package	48pin QFN
Features	<ul style="list-style-type: none"> It is an ultra-high performance, ultralow cost, and ultralow power fully integrated 10/100/1000 Mbps NIC/LOM Ethernet. The AR8131L combines a 10/100/1000BASE-T GbE media access controller (MAC), a triplespeed Ethernet physical layer transceiver (PHY), and a PCI Express bus interface. The AR8131L is compliant with IEEE 802.3u specification for 10/100 Mbps Ethernet and IEEE 802.3ab specification for 1000 Mbps Ethernet. The AR8131L device combines pulse shaping, Tx/Rx PCS, echo canceller, NEXT canceller, equalizer, decoder, and timing recovery functions to deliver robust signal performance in noisy environments. The AR8131L GbE controller supports checksum off-load features for IP, TCP, and UDP, lowering CPU utilization and optimizing network performance.

Keyboard

Item	Specification
Keyboard Controller	Winbond WPCE775LA0DG
Total number of keypads	US: 86 UK: 86 UI: 86 GERMAN: 86
Windows logo key	Yes
Internal & external keyboard work simultaneously	Plug USB keyboard to the USB port directly: Yes
Features	<ul style="list-style-type: none"> Plug USB keyboard to the USB port directly: Yes

Media Card Reader

Item	Specification
Chipset	Alcor AU6433
Features	<ul style="list-style-type: none"> Fully compatible with USB2.0 High Speed and backward compatible with USB1.1 specifications Supports multiple flash card interfaces, including SD/MMC/xD/MS. Supports single LUN 48-pin LQFP

Item	Specification
Compliance	<ul style="list-style-type: none"> Complies with USB Device Class Definition for Mass Storage and Bulk-Transport V1.0 Complies with Secure Digital Card (SD) specification up to ver. 2.0(SDHC) Complies with MultiMedia Card (MMC) specification up to ver. 4.2 Complies with Memory Stick (MS) specification up to ver. 1.43 Complies with Memory Stick PRO (MS_Pro) specification up to ver. 1.03 Complies with Memory Stick PRO-HG (MS PRO-HG) specification up to ver. 1.01 Complies with Memory Stick Interface Guideline for PC peripheral devices with Memory Stick Slot ver. 1.16-00 Complies with xD-Picture Card (xD) specification up to version 1.2
Interface	<ul style="list-style-type: none"> USB 2.0
Power	<ul style="list-style-type: none"> 3.3V

Camera

Item	Specifications		
Vendor and model	Chicony CNF9011/9048	Lite-on 09P2SF001	Suyin CN0316-S30C-OV06-1
Interface	USB 2.0		
Optical aperture	N/A		
Focusing range	17.4 cm - infinity	19 CM - infinity	40 CM - infinity
Dimensions (L x W x H mm)	68 X 8 X 3.64 mm	68 X 8 X 3.84 mm	65 X 7.9 X 3.8 mm
Sensor type	CMOS		
Pixel resolution	640X480		

Wireless LAN

Item	Specification	Specification	Specification	Specification
Manufacturer	Foxconn	Foxconn	Intel	Intel
Type	Atheros AR9283	T77H121.01	WiFi Link 1000	Shirley Peak
PHY Mode Supported	b,g,n.	b,g,n.	b, g, n.	a, b, g, n.

Item	Specification	Specification
Manufacturer	Intel	Lite-on
Type	Wifi Link 5000	Atheros AR5B93
PHY Modes Supported	a, b, g, n.	b, g, n.

3G Module

Item	Specifications
3G Module	<ul style="list-style-type: none"> Qualcomm Gobi1000 Huawei EM770W
Technical Standard	GSM / GPRS/ EGPRS MSC 12 / DTM Item/ WCDMA R5 / HSDPA 7.2Mbps / HSUPA 5.76Mbps

Item	Specifications
Interface	USB 2.0
Antenna	1 x 2

Embedded Controller

Item	Specifications
Chipset	Winbond WPCE775LA0DG
Features	<ul style="list-style-type: none"> • Shared SPI BIOS flash memory with page programming support. • High-accuracy, high-speed ADC. • Up to 95 GPIO ports (including keyboard scanning) with a variety of wake-up events (up to 42 wake-up inputs). • 16-bit RISC core, with up to 4 Mbytes of external address space, running at up to 25 MHz. • 128-pin LQChipFP

Battery

Item	Specifications
	6 Cell
Vendor & model name	SIMPLO UM09F70 3S2P SANYO UM09F36 3S2P
Battery Type	Li-ion
Pack capacity	SANYO 6 cell 5600mAh SAMSUNG 6 cell 5600mAh LGC 6 cell 5600mAh
Number of battery cell	6
Package configuration	3 cells in series, 2 series in parallel
Normal voltage	11.1
Charge voltage	12.6

System Utilities

BIOS Setup Utility

The BIOS Setup Utility is a hardware configuration program built into your computer's BIOS (Basic Input/Output System).

Your computer is already properly configured and optimized, and you do not need to run this utility. However, if you encounter configuration problems, you may need to run Setup. Please also refer to Chapter 4 Troubleshooting when problem arises.

To activate the BIOS Utility, press **F2** during POST (when **Press <F2> to enter Setup** message is prompted on the bottom of screen).

Press **F2** to enter setup. The default parameter of F12 Boot Menu is set to "disabled". If you want to change boot device without entering BIOS Setup Utility, please set the parameter to "enabled".

Press **<F12>** during POST to enter multi-boot menu. In this menu, user can change boot device without entering BIOS SETUP Utility.

Navigating the BIOS Utility

There are six menu options: Information, Main, Advanced, Security, Power, Boot, and Exit.

Follow these instructions:

- To choose a menu, use the left and right arrow keys.
- To choose an item, use the up and down arrow keys.
- To change the value of a parameter, press **F5** or **F6**.
- A plus sign (+) indicates the item has sub-items. Press **Enter** to expand this item.
- Press **Esc** while you are in any of the menu options to go to the Exit menu.
- In any menu, you can load default settings by pressing **F9**. You can also press **F10** to save any changes made and exit the BIOS Setup Utility.

NOTE: You can change the value of a parameter if it is enclosed in square brackets. Navigation keys for a particular menu are shown on the bottom of the screen. Help for parameters are found in the Item Specific Help part of the screen. Read this carefully when making changes to parameter values. **Please note that system information is subject to different models.**

Information

The Information screen displays a summary of your computer hardware information.

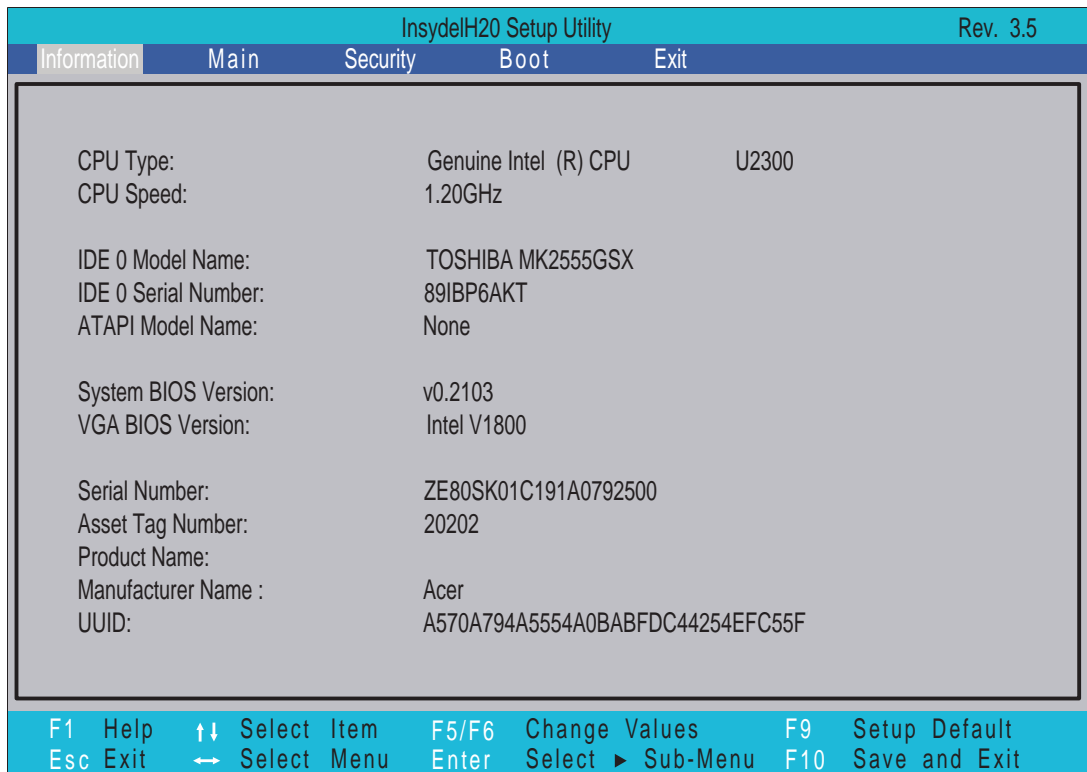

NOTE: The system information is subject to different models.

Parameter	Description
CPU Type	This field shows the CPU type and speed of the system.
CPU Speed	This field shows the speed of the CPU.
HDD Model Name	This field shows the model name of HDD installed on primary IDE master.
HDD Serial Number	This field displays the serial number of HDD installed on primary IDE master.
ATAPI Model Name	This field displays the model name of the installed ODD drive.
System BIOS Version	Displays system BIOS version.
VGA BIOS Version	This field displays the VGA firmware version of the system.
Serial Number	This field displays the serial number of this unit.
Asset Tag Number	This field displays the asset tag number of the system.
Product Name	This field shows product name of the system.
Manufacturer Name	This field displays the manufacturer of this system.
UUID Number	Universally Unique Identifier (UUID) is an identifier standard used in software construction, standardized by the Open Software Foundation (OSF) as part of the Distributed Computing Environment (DCE).

Main

The Main screen allows the user to set the system time and date as well as enable and disable boot option and recovery.

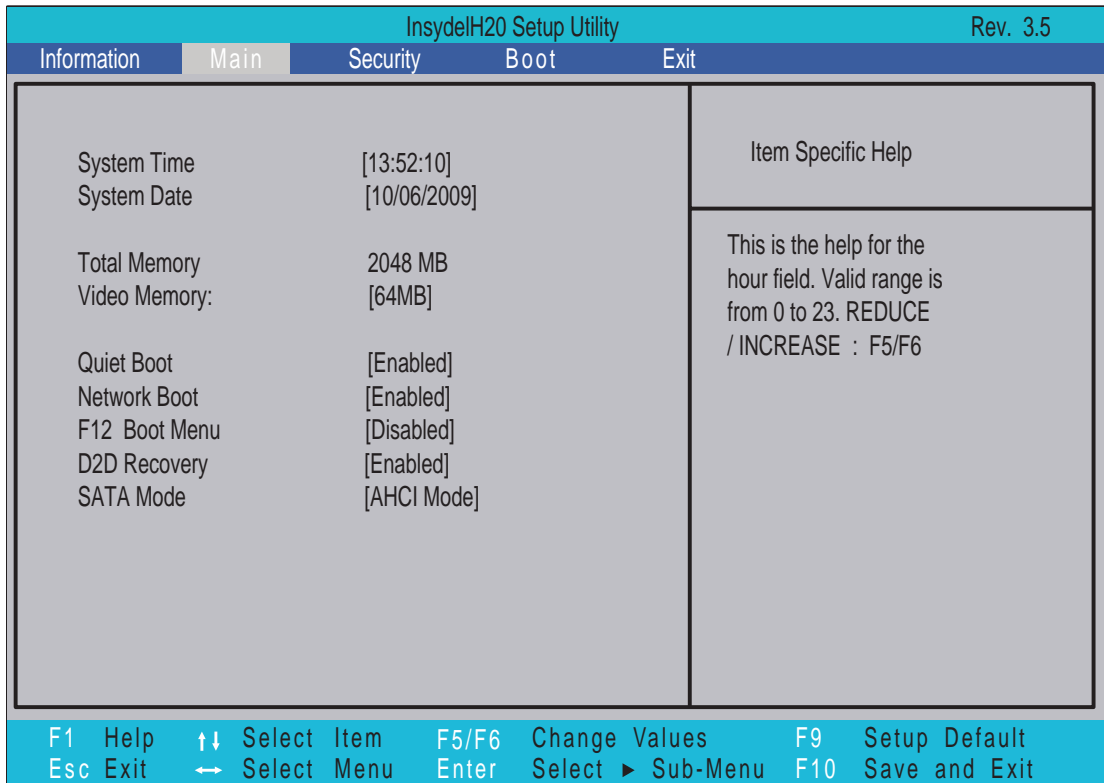

NOTE: The screen above is for your reference only. Actual values may differ.

The table below describes the parameters in this screen. Settings in **boldface** are the default and suggested parameter settings.

Parameter	Description	Format/Option
System Time	Sets the system time. The hours are displayed with 24-hour format.	Format: HH:MM:SS (hour:minute:second)
System Date	Sets the system date.	Format MM/DD/YYYY (month/day/year)
Total Memory	This field reports the memory size of the system. Memory size is fixed to 2048 MB.	N/A
Video Memory	Shows the video memory size. VGA Memory size=32 MB	N/A
Quick Boot	Allows startup to skip certain tests while booting, decreasing the time needed to boot the system.	Option: Enabled or Disabled
Network Boot	Enables, disables the system boot from LAN (remote server).	Option: Enabled or Disabled
F12 Boot Menu	Enables, disables Boot Menu during POST.	Option: Enabled or Enabled
D2D Recovery	Enables, disables D2D Recovery function. The function allows the user to create a hidden partition on hard disc drive to store operation system and restore the system to factory defaults.	Option: Enabled or Disabled
SATA Mode	Control the mode in which the SATA controller should operate.	Option: AHCI or IDE

Security

The Security screen contains parameters that help safeguard and protect your computer from unauthorized use.

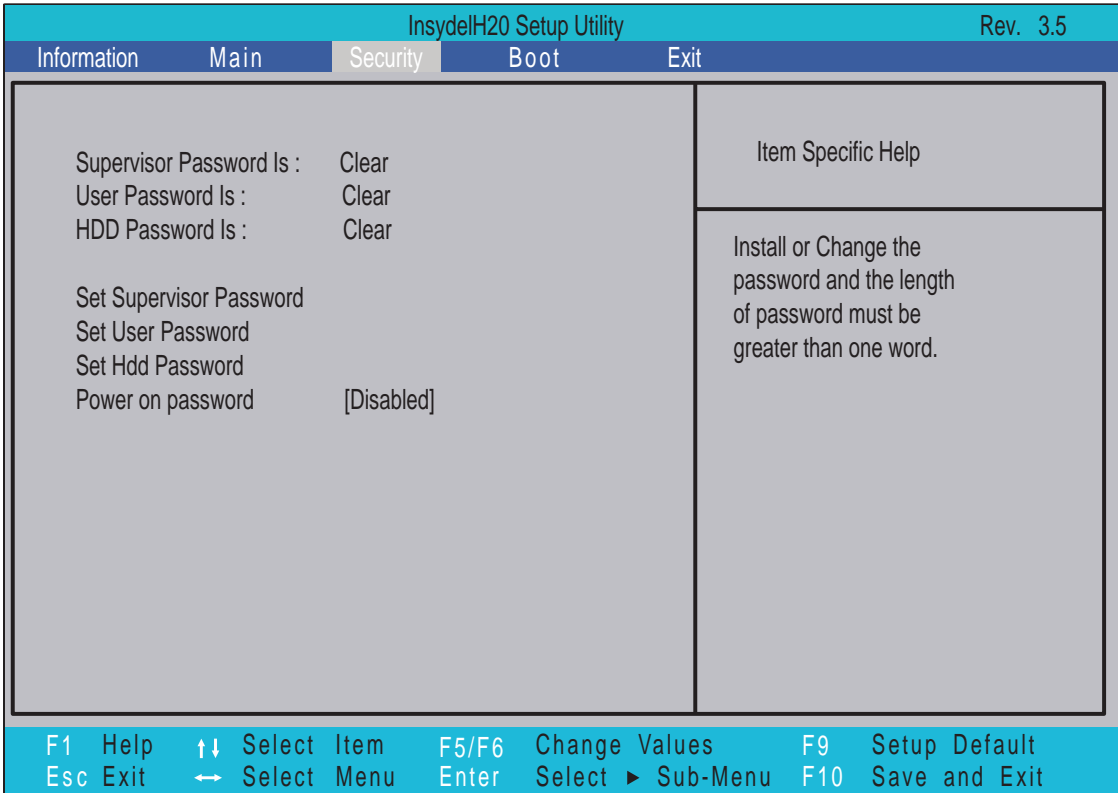

The table below describes the parameters in this screen. Settings in **boldface** are the default and suggested parameter settings.

Parameter	Description	Option
Supervisor Password Is	Shows the setting of the Supervisor password	Clear or Set
User Password Is	Shows the setting of the user password.	Clear or Set
Set Supervisor Password	Press Enter to set the supervisor password. When set, this password protects the BIOS Setup Utility from unauthorized access. The user can not either enter the Setup menu nor change the value of parameters.	
Set User Password	Press Enter to set the user password. When user password is set, this password protects the BIOS Setup Utility from unauthorized access. The user can enter Setup menu only and does not have right to change the value of parameters.	
Set Hdd Password	Enter HDD password.	
Power on password	Defines whether a password is required or not while the events defined in this group happened. The following sub-options are all requires the Supervisor password for changes and should be grayed out if the user password was used to enter setup.	Enabled or Disabled

NOTE: When you are prompted to enter a password, you have three tries before the system halts. Don't forget your password. If you forget your password, you may have to return your notebook computer to your dealer to reset it.

Setting a Password

Follow these steps as you set the user or the supervisor password:

1. Use the ↑ and ↓ keys to highlight the Set Supervisor Password parameter and press the **Enter** key. The Set Supervisor Password box appears:

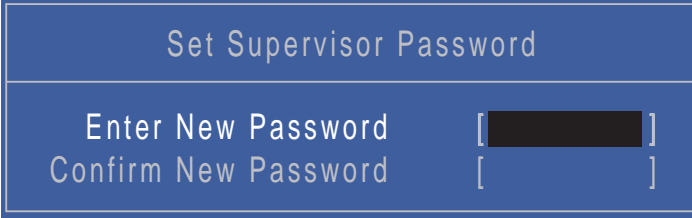

Set Supervisor Password	
Enter New Password	[██████████]
Confirm New Password	[]

2. Type a password in the “Enter New Password” field. The password length can not exceeds 8 alphanumeric characters (A-Z, a-z, 0-9, not case sensitive). Retype the password in the “Confirm New Password” field.

IMPORTANT: Be very careful when typing your password because the characters do not appear on the screen.

3. Press **Enter**. After setting the password, the computer sets the User Password parameter to “Set”.
4. If desired, you can opt to enable the Password on boot parameter.
5. When you are done, press F10 to save the changes and exit the BIOS Setup Utility.

Removing a Password

Follow these steps:

1. Use the ↑ and ↓ keys to highlight the Set Supervisor Password parameter and press the **Enter** key. The Set Password box appears:



Set Supervisor Password	
Enter Current Password	[██████████]
Enter New Password	[]
Confirm New Password	[]

2. Type the current password in the Enter Current Password field and press **Enter**.
3. Press **Enter** twice **without** typing anything in the Enter New Password and Confirm New Password fields. The computer then sets the Supervisor Password parameter to “Clear”.
4. When you have changed the settings, press u to save the changes and exit the BIOS Setup Utility.

Changing a Password

1. Use the ↑ and ↓ keys to highlight the Set Supervisor Password parameter and press the **Enter** key. The Set Password box appears.



The screenshot shows a blue BIOS screen titled "Set Supervisor Password". Below the title, there are three input fields, each with a label and a pair of square brackets: "Enter Current Password", "Enter New Password", and "Confirm New Password". The first field contains a blacked-out password.

2. Type the current password in the Enter Current Password field and press **Enter**.
3. Type a password in the Enter New Password field. Retype the password in the Confirm New Password field.
4. Press **Enter**. After setting the password, the computer sets the User Password parameter to "Set".
5. If desired, you can enable the Password on boot parameter.
6. When you are done, press **F10** to save the changes and exit the BIOS Setup Utility.

If the verification is OK, the screen will display as following.

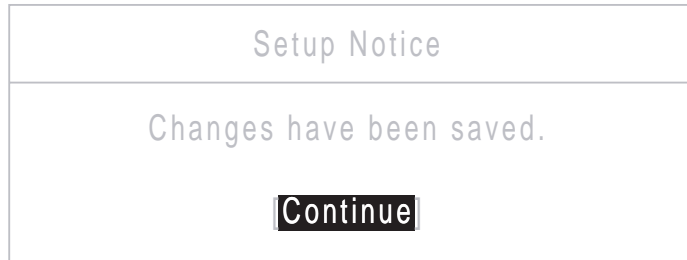

The screenshot shows a white BIOS screen titled "Setup Notice". Below the title, the text "Changes have been saved." is displayed. At the bottom, there is a black button with the word "Continue" in white.

The password setting is complete after the user presses **Enter**.

If the current password entered does not match the actual current password, the screen will show you the Setup Warning.



The screenshot shows a white BIOS screen titled "Setup Warning" in red. Below the title, the text "Invalid Password." is displayed in red. At the bottom, there is a black button with the word "Continue" in white.

If the new password and confirm new password strings do not match, the screen displays the following message.



The screenshot shows a white BIOS screen titled "Setup Warning" in red. Below the title, the text "Passwords do not match. Re-enter password." is displayed in red. At the bottom, there is a black button with the word "Continue" in white.

Boot

This menu allows the user to decide the order of boot devices to load the operating system. Bootable devices includes the USB diskette drives, the onboard hard disk drive and the DVD drive in the module bay.

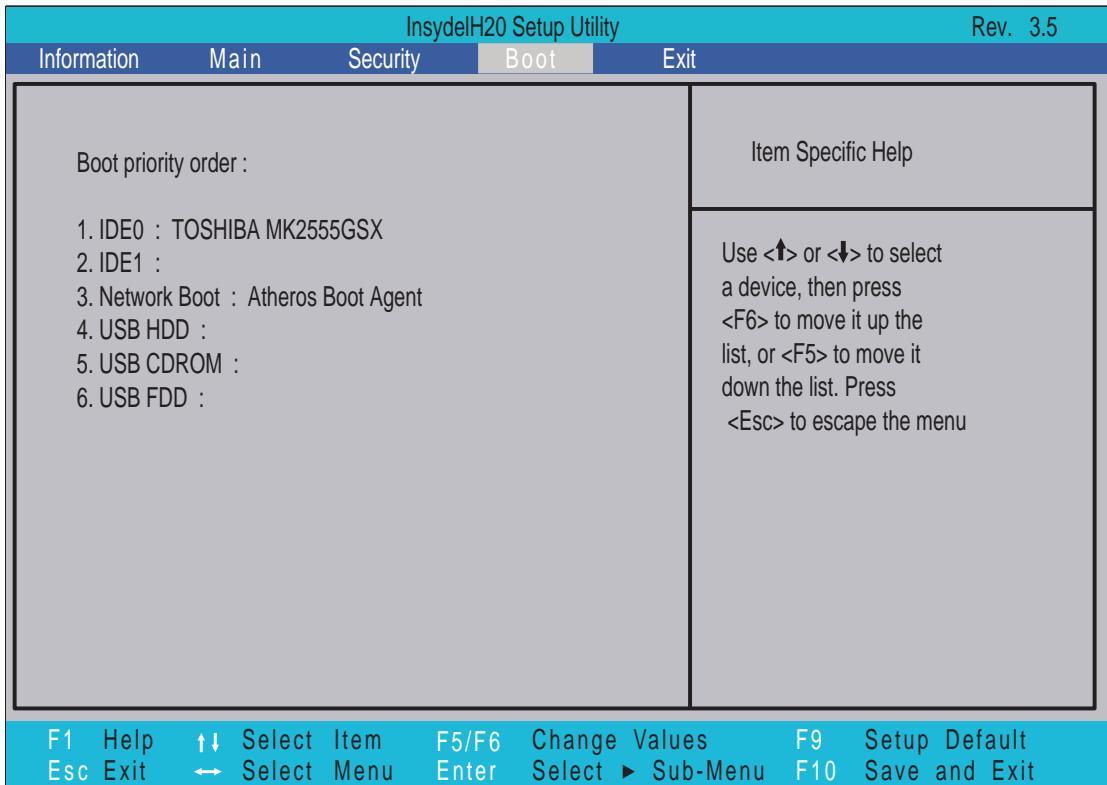

Follow the on-screen instructions to adjust the order in which the devices boot.

Exit

The Exit screen allows you to save or discard any changes you made and quit the BIOS Utility.

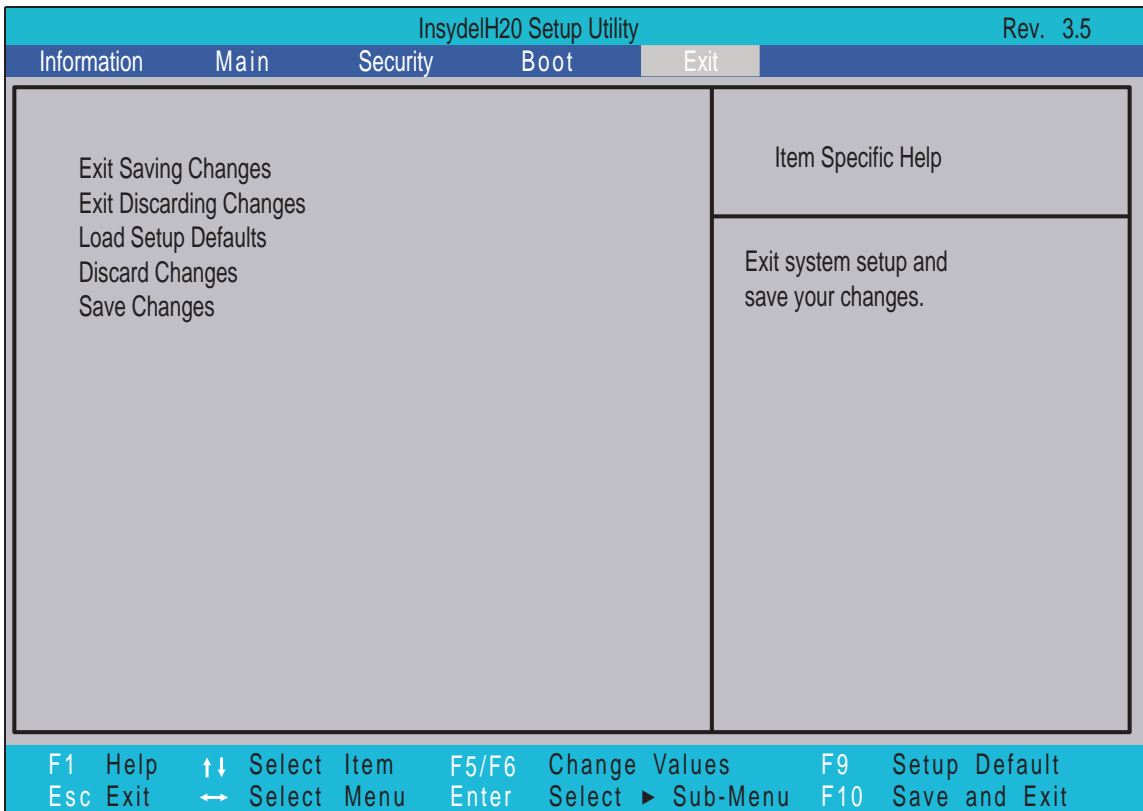

The table below describes the parameters in this screen.

Parameter	Description
Exit Saving Changes	Exit System Setup and save your changes to CMOS.
Exit Discarding Changes	Exit utility without saving setup data to CMOS.
Load Setup Default	Load default values for all SETUP item.
Discard Changes	Load previous values from CMOS for all SETUP items.
Save Changes	Save Setup Data to CMOS.

BIOS Flash Utility

The BIOS flash memory update is required for the following conditions:

- New versions of system programs
- New features or options
- Restore a BIOS when it becomes corrupted.

To run the BIOS flash utility:

1. Copy the BIOS flash tool and the BIOS into a USB flash disk.
2. Set the computer to boot from the USB flash disk. See “Boot” on page 29.
3. On boot-up enter at the DOS prompt:

C:\> flashit.exe v3106.fd /dc /beep:2000

DOS Flash Utility

Perform the following steps to use the DOS Flash Utility:

1. Press F2 during boot to enter the Setup Menu.
2. Select **Boot Menu** to modify the boot priority order, for example, if using USB HDD to Update BIOS, move USB HDD to position 1.

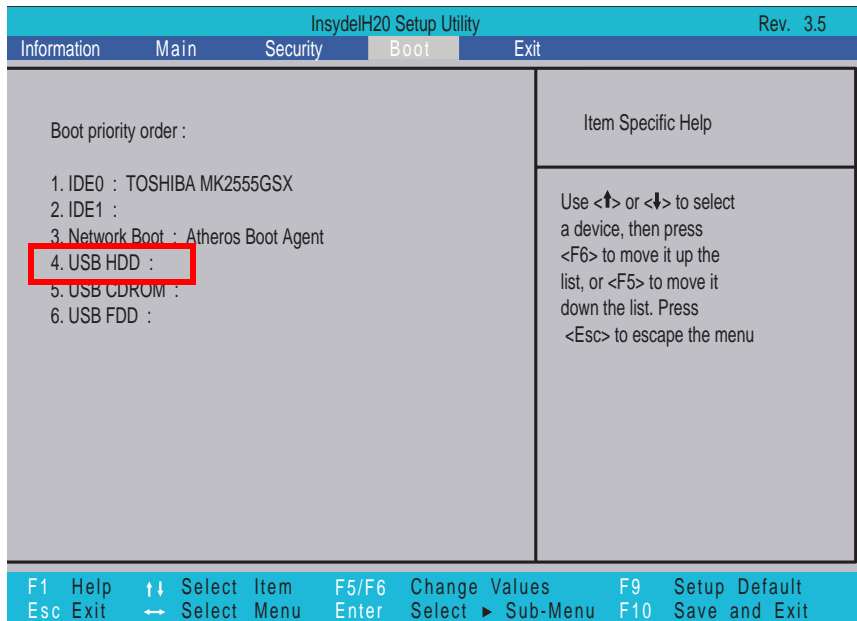

3. Execute the **FLASH.BAT** batch file to update BIOS.

The flash process begins as shown.



4. In flash BIOS, the message **Please do not remove AC Power Source** displays.

NOTE: If the AC power is not connected, the following message displays.



Plug in the AC power to continue.

5. Flash is complete when the message Flash programming complete displays.

WinFlash Utility

Perform the following steps to use the WinFlash Utility:

1. Put the BIOS:ZE8_v3106.fd file under WinFlash file root.

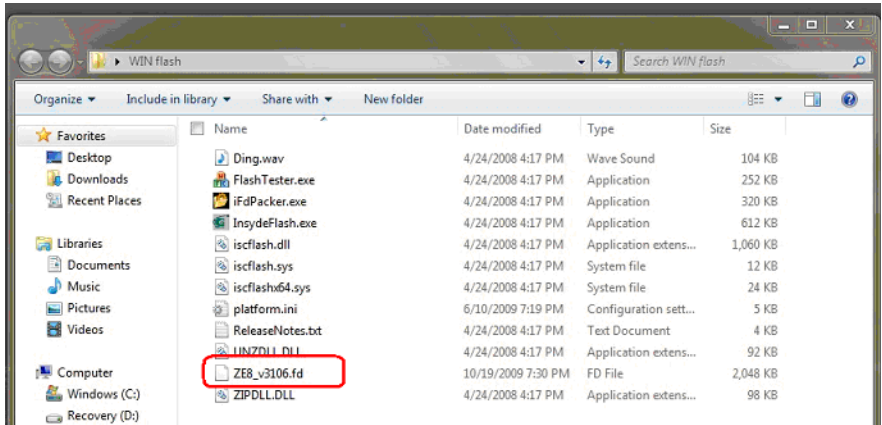

1. Double click the WinFlash executable.

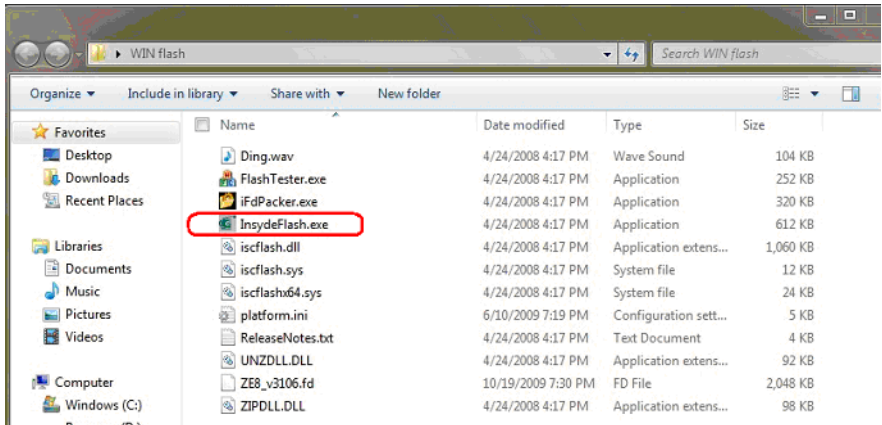

2. Click **OK** to begin the update. A progress screen displays.



3. When the process is complete, close all programs and applications and reboot the system.

Remove HDD/BIOS Password Utilities

This section provide you with removing HDD/BIOS method:

Remove HDD Password:

When the user keys in the wrong password three times, the system reports the following error code to user.

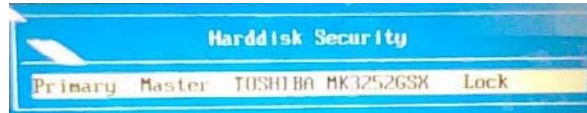

To unlock the HDD password, perform the following steps:

1. Press **Enter** to display the Select Item screen.

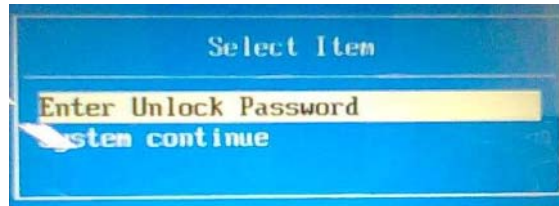

2. Select **Enter Unlock Password** and press **Enter**.

An Unlock Password displays.



3. Make a note of the key, **76943488** in the example.
4. Boot up the system to a removable bootable drive containing DOS and the UnlockHD.EXE program and open a DOS prompt. For instructions on changing boot priority see "Boot" on page 29.
5. Enter the **UnlockHD.EXE** command and input the key to create an unlock code. Make a note of the result, for example **46548274**.
6. Reboot to the hard disk and wait for the error code to reappear.
7. Press **Enter** to display the Select Item screen.
8. Select **Enter Unlock Password** and press **Enter**.
9. Enter the unlock code generated by UnlockHD.EXE.
10. Save and exit the BIOS to complete the process.

Removing BIOS Passwords:

If you key in the wrong Supervisor Password three times, System Disabled displays on the screen. See the image below.

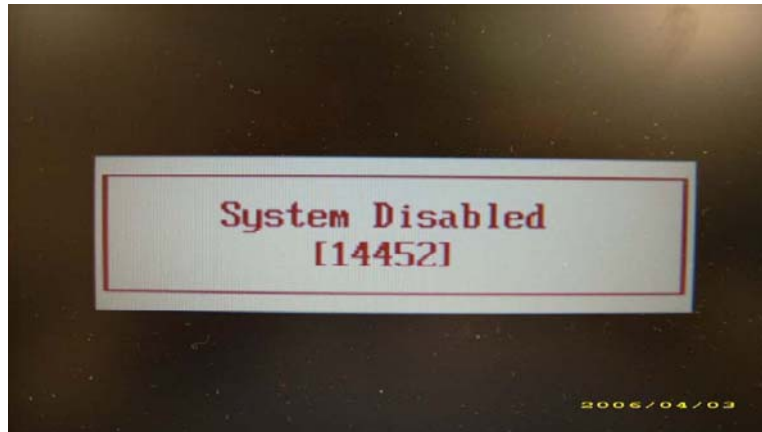

To reset the BIOS password, run clnpwd.exe as follows:

1. From a DOS prompt, Execute **clnpwd.exe**

```
d:\Clnpwd>clnpwd
ACER Clean Password Utility V1.00
Press 1 or 2 to clean any password shown as below
    1.User Password
    2.Supervisor Password

Clean User Password Successfully!
```

2. Press 1 or 2 to clean the desired password shown on the screen.

The onscreen message determines whether the function is successful or not.

Miscellaneous Utilities

Using Boot Sequence Selector

Boot Sequence Selector allows the boot order to be changes without accessing the BIOS. To use Boot Sequence Selector, perform the following steps:

1. Enter into DOS.
2. Execute BS.exe to display the usage screen.

```
d:\B00TSEQ>bs
*** Boot Sequence Selector Version 0.03 ***
Create by Rockwell Chuang 10/01/2005.
Usage:
      BS [ 1 | 2 | 3 | 4 ]
BS 1 : [ Floppy ] => [ HardDisk ] => [ CD-ROM ] => [ LAN   ]
BS 2 : [ HardDisk ] => [ CD-ROM ] => [ LAN   ] => [ Floppy ]
BS 3 : [ CD-ROM ] => [ HardDisk ] => [ LAN   ] => [ Floppy ]
BS 4 : [ LAN   ] => [ Floppy ] => [ HardDisk ] => [ CD-ROM ]
d:\B00TSEQ>
```

3. Select the desired boot sequence by entering the corresponding sequence, for example, enter BS2 to change the boot sequence to HDD|CD ROM|LAN|Floppy.

Using DMITools

The DMI (Desktop Management Interface) Tool copies BIOS information to eeprom to be used in the DMI pool for hardware management.

When the BIOS displays **Verifying DMI pool data** it is checking the table correlates with the hardware before sending to the operating system (Windows, etc.).

To update the DMI Pool, perform the following steps:

1. Enter into DOS.
2. Execute **dmitools.exe**. The following messages show dmitools usage:

```
*** Compal DMI String R/W Utility Ver1.40 for 2006/03/14 ***

Usage:

DMITOOLS [ /R | /WP | /WS | /WU ] [ STRING ]

[R]   : Read DMI Information from Memory
[WM]  : Write Manufacturer Name to EEPROM. (Max.= 16 characters)
[WP]  : Write Product Name to EEPROM.      (Max.= 16 characters)
[WS]  : Write Serial Number to EEPROM     (Max.= 22 characters)
[WU]  : Write UUID to EEPROM.              (Ignore String   )
[WA]  : Write Asset Tag to EEPROM.        (Max.= 32 characters)
```

IMPORTANT:The following write examples (2 to 5) require a system reboot to take effect

Example 1: Read DMI Information from Memory

Input:

```
dmitools /r
```

Output:

```
Manufacturer (Type1, Offset04h): Acer  
Product Name (Type1, Offset05h): Aspire one xxxxx  
Serial Number (Type1, Offset07h): 01234567890123456789  
UUID String (Type1, Offset08h): xxxxxxxx-xxxx-xxxx-xxxx-xxxxxxxxxxxx  
Asset Tag (Type3, Offset04h): Acer Asstag
```

Example 2: Write Product Name to EEPROM

Input:

```
dmitools /wp Acer
```

Example 3: Write Serial Number to EEPROM

Input:

```
dmitools /ws 01234567890123456789
```

Example 4: Write UUID to EEPROM

Input:

```
dmitools /wu
```

Example 5: Write Asset Tag to EEPROM

Input:

```
dmitools /wa Acer Asstag
```

Using the LAN MAC Utility

Perform the following steps to write MAC information to eeprom:

1. Use a text editor, for example Notepad, to edit the MAC.CFG file as shown:

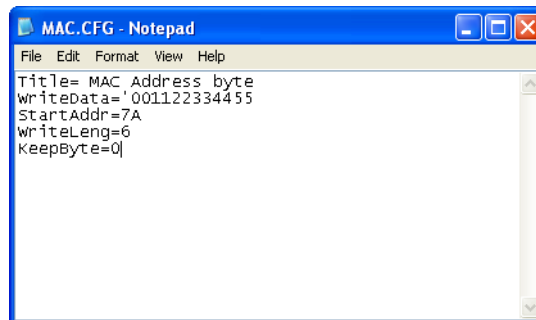

- WriteData= '001122334455' <----- MAC value
 - StartAddr=7A <----- MAC address
 - WriteLeng=6 <----- MAC value length
 - KeepByte=0 <----- can be any value
2. Boot into DOS.
 3. Execute **MAC.BAT** to write MAC information to eeprom.

Machine Disassembly and Replacement

This chapter contains step-by-step procedures on how to disassemble the notebook computer for maintenance and troubleshooting.

Disassembly Requirements

To disassemble the computer, you need the following tools:

- Wrist grounding strap and conductive mat for preventing electrostatic discharge
- Flat screwdriver
- Philips screwdriver
- Plastic flat screwdriver
- Plastic tweezers

NOTE: The screws for the different components vary in size. During the disassembly process, group the screws with the corresponding components to avoid mismatch when putting back the components.

Related Information

The product previews seen in the disassembly procedures may not represent the final product color or configuration.

IMPORTANT: Cable paths and positioning may not represent the actual model. During the removal and replacement of components, ensure all available cable channels and clips are used and that the cables are replaced in the same position.

General Information

Pre-disassembly Instructions

Before proceeding with the disassembly procedure, make sure that you do the following:

1. Turn off the power to the system and all peripherals.
2. Unplug the AC adapter and all power and signal cables from the system.



3. Place the system on a flat, stable surface.

-
4. Remove the battery pack.

Disassembly Process

The disassembly process is divided into the following sections:

- External components disassembly
- Main unit disassembly
- LCD module disassembly

The flowcharts provided in the succeeding disassembly sections illustrate the entire disassembly sequence. Observe the order of the sequence to avoid damage to any of the hardware components. For example, if you want to remove the Mainboard, you must first remove the Keyboard, and LCD Module then disassemble the inside assembly frame in that order.

Main Screw List

Screw	Quantity	Part Number
M2*2.5 (silver)	8	86.TPK07.001
M2*3	7	86.ARE07.002
M2*4	26	86.W0107.003
M2*5	24	86.TG607.004

External Module Disassembly Process

NOTE: The product previews seen in the disassembly procedures may not represent the final product color or configuration.

External Modules Disassembly Flowchart

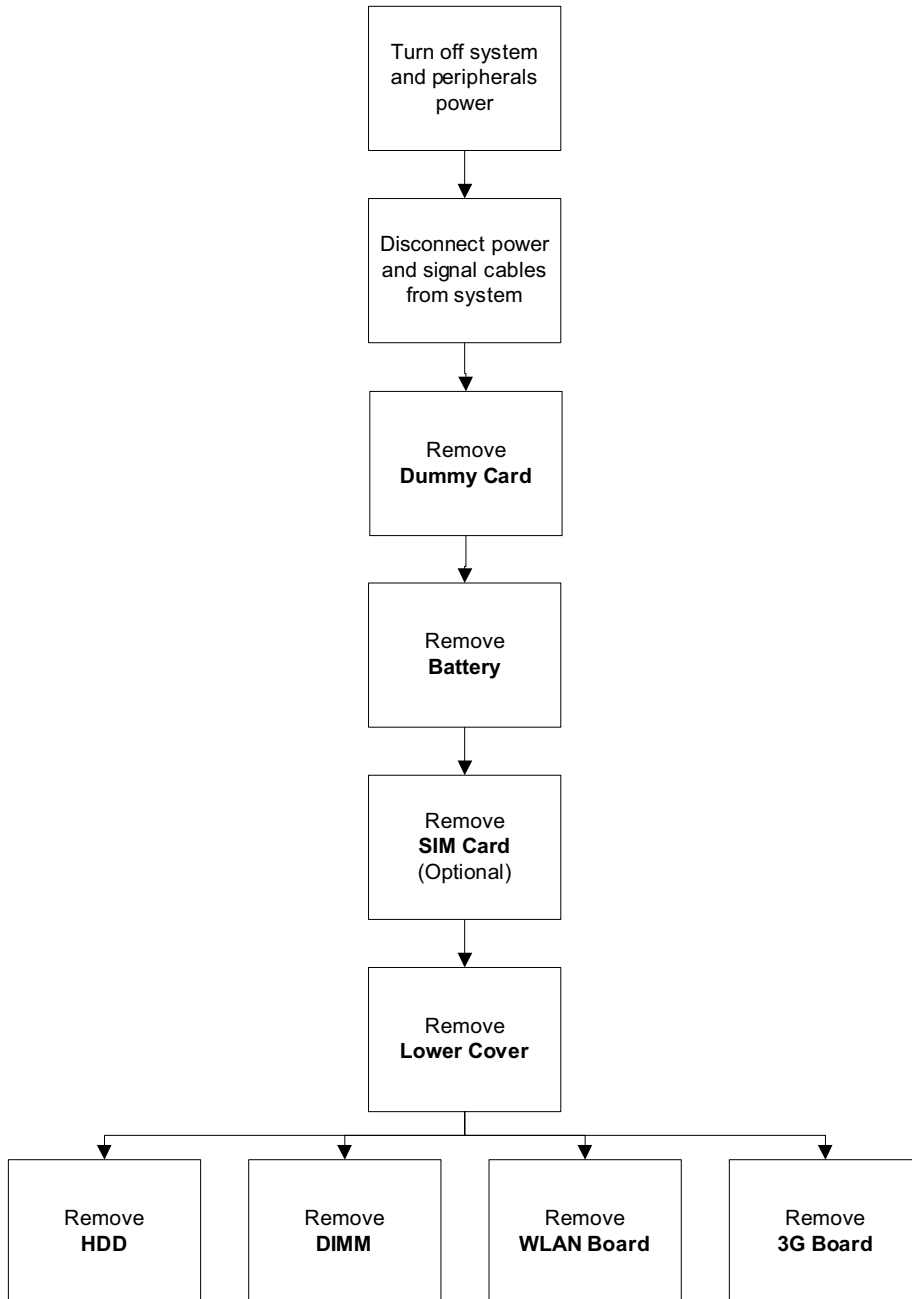

Screw List

Step	Screw	Quantity	Part No.
WLAN	M2*3	1	86.ARE07.002
3G Module	M2*3	1	86.ARE07.002

Removing the Dummy Card

1. Press the card in to allow it to spring out.



2. Pull the dummy card out.



Removing the Battery Pack

1. Turn the computer over.
2. Slide the battery lock/unlock latch to the unlock position.



3. Slide and hold the battery release latch to the release position (1), grasp the battery edge closest to the release latch and pull the battery up and away (2).

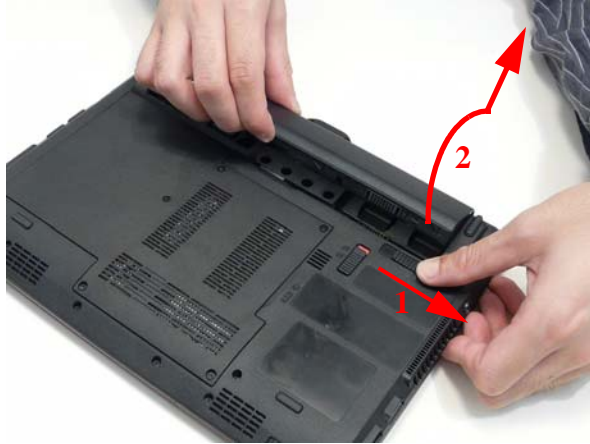

Removing the SIM Card

1. See "Removing the Dummy Card" on page 42.
2. Press the SIM card in to allow it to spring out.



3. Remove the SIM card.



Removing the Module Cover

1. Loosen the six (6) captive screws.



2. Pry up the cover in the location indicated.



3. Lift the cover up and away.



Removing the Hard Disk Drive Module

1. See “Removing the Dummy Card” on page 42.
2. See “Removing the Module Cover” on page 44.
3. Pry up the HDD FCP lock.

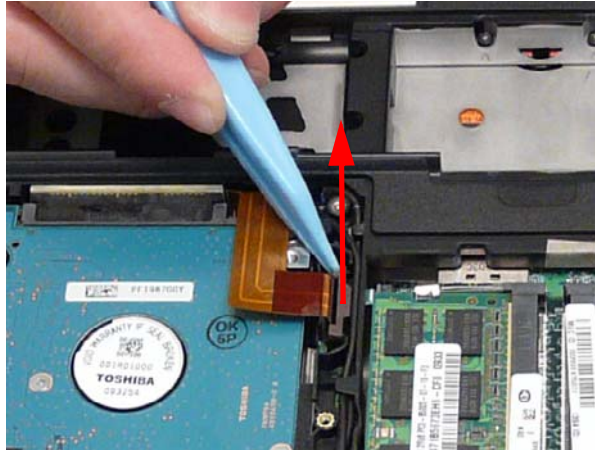

4. Lift out the HDD FCP.



5. Peel the adhesive black tape off the HDD.



6. Grasp the black tape, pulling up the HDD.

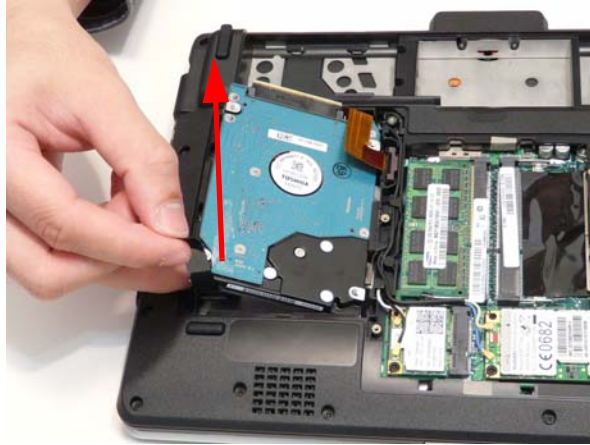

7. Lift the HDD out of the bay.



8. Remove the HDD cable from the HDD.

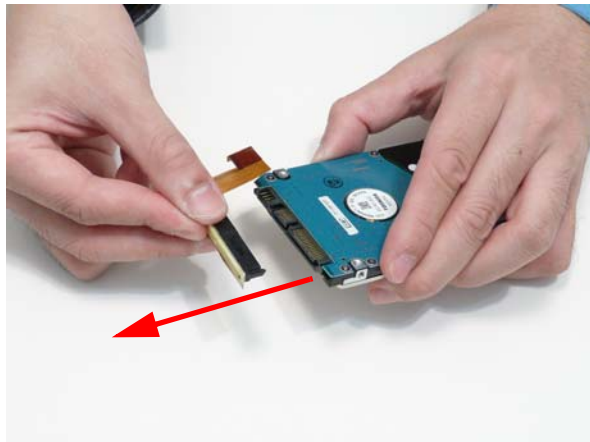

Removing the DIMM Module

1. See “Removing the Dummy Card” on page 42.
2. See “Removing the Module Cover” on page 44.
3. Push out the release latches on both sides of the DIMM socket to release the DIMM module.



4. Lift the DIMM module out.



Removing the WLAN Board

1. See "Removing the Dummy Card" on page 42.
2. See "Removing the Module Cover" on page 44.
3. Detach the two (2) cables.

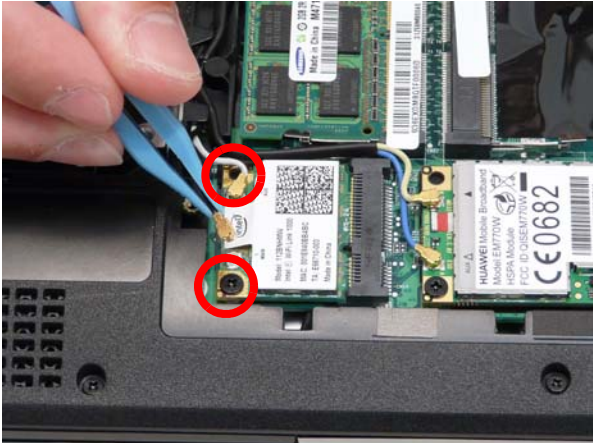

4. Remove the one (1) screw.



Step	Screw	Quantity	Screw Type.
WLAN	M2*3	1	

5. Remove the WLAN board.



Removing the 3G Module

1. See “Removing the Dummy Card” on page 42.
2. See “Removing the Module Cover” on page 44.
3. Detach the two cables.



4. Remove the one (1) screw.



Step	Screw	Quantity	Screw Type.
3G Module	M2*3	1	

5. Remove the 3G module.



Main Unit Disassembly Process

IMPORTANT: Cable paths and positioning may not represent the actual model. During the removal and replacement of components, ensure all available cable channels and clips are used and that the cables are replaced in the same position.

NOTE: The product previews seen in the disassembly procedures may not represent the final product color or configuration.

Main Unit Disassembly Flowchart

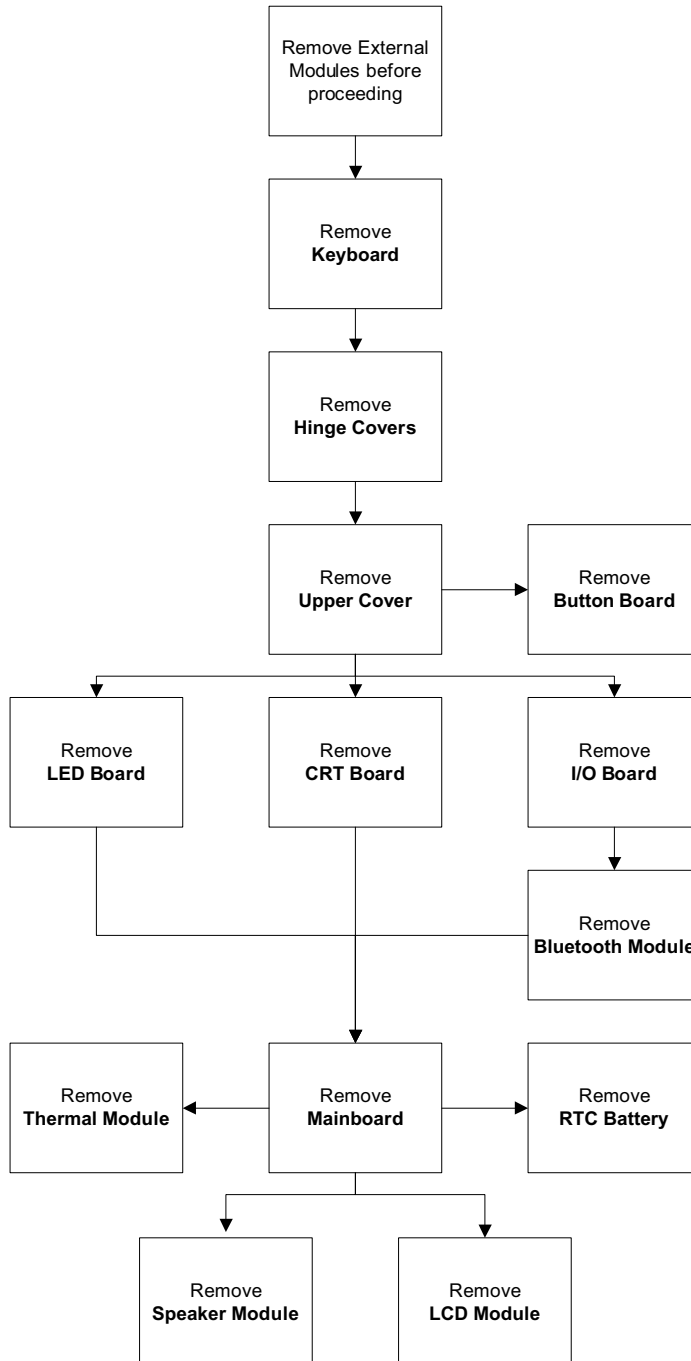

Screw List

Step	Screw	Quantity	Part No.
Lower Cover	M2*5	16	86.TPK07.001
	M2*4	6	86.W0107.003
Upper Cover	M2*5	6	86.TPK07.001
	M2*2.5	4	86.TPK07.001
Hinge Cover	M2*3	3	86.ARE07.002
Button Board	M2*3	2	86.ARE07.002
I/O Board	M2*4	1	86.W0107.003
LED Board	M2*4	2	86.W0107.003
CRT Board	M2*4	1	86.W0107.003
Main Board	M2*4	2	86.W0107.003
Speaker	M2*3	2	86.ARE07.002
LCD Module	M2*4	5	86.W0107.003

Removing the Keyboard

IMPORTANT: The keyboard is easily warped or damaged during the removal process. Take care not to use excessive force when removing the keyboard and replace if any damage occurs.

1. See "Removing the Dummy Card" on page 42.
2. Push in the four (4) latches on the top edge of the keyboard.



3. Lift the keyboard up and flip over.



-
4. Unlock the FCP.

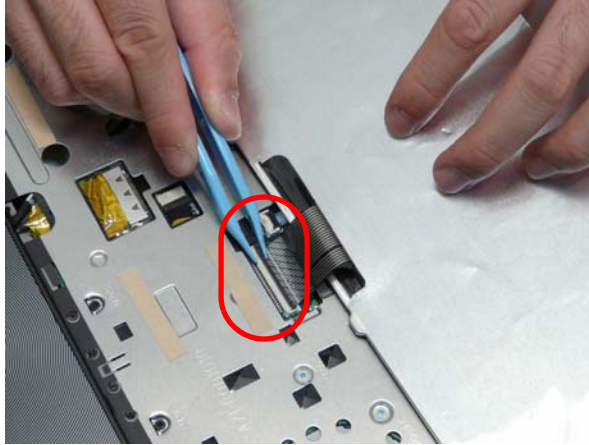

5. Remove the FCP and keyboard.

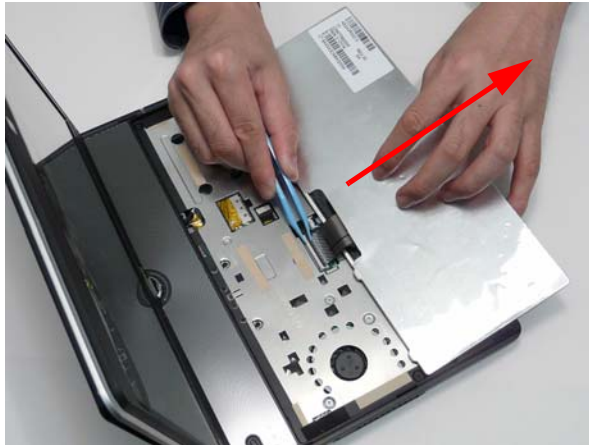

Removing the Hinge Covers

1. Remove the three (3) screws.



Step	Screw	Quantity	Screw Type.
Hinge Covers	M2*3	3	

2. Push up on the hinge bezel firmly to loosen the hinge cap.

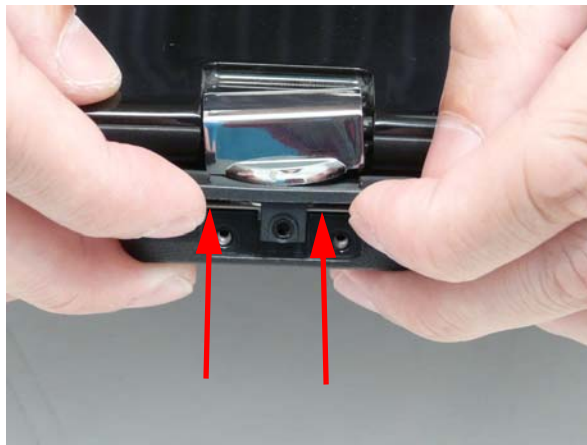

3. Lift the LCD module to a partially open position.



-
4. Remove the hinge cap.





5. Remove the hinge bezel.

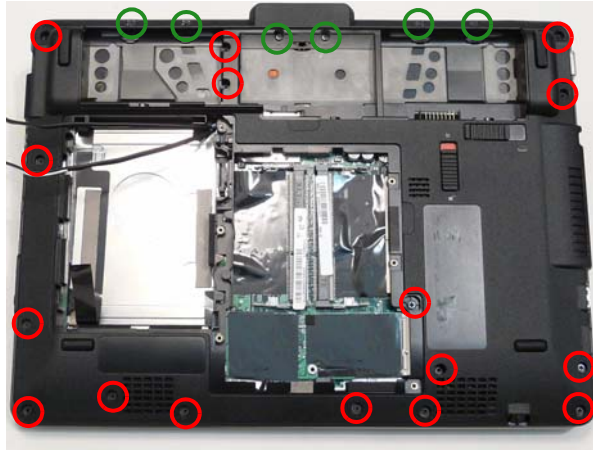

Removing the Upper Cover

1. See "Removing the Keyboard" on page 53.
2. See "Removing the Hinge Covers" on page 55.
3. Remove the twenty-two (22) screws in the lower cover.



Step	Screw	Quantity	Screw Type.
Lower Cover	M2*5 (Red Call Out)	16	
	M2*4 (Green Call Out)	6	

4. Flip the computer over and unlock the button board cable.

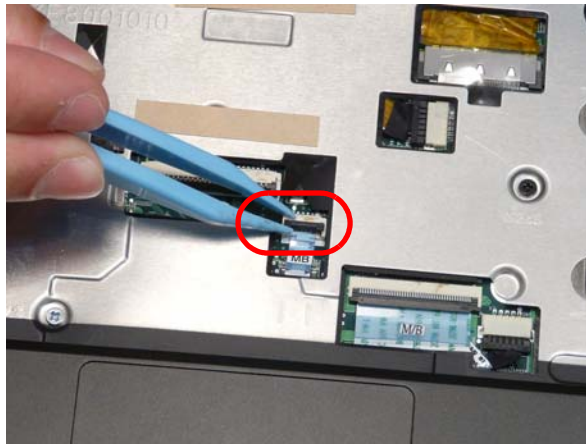

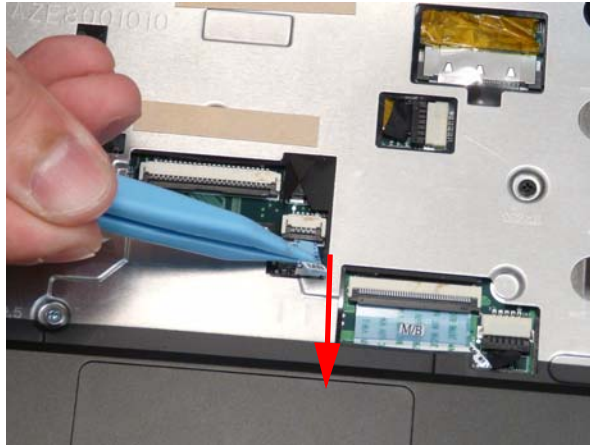

5. Disconnect the button board cable.

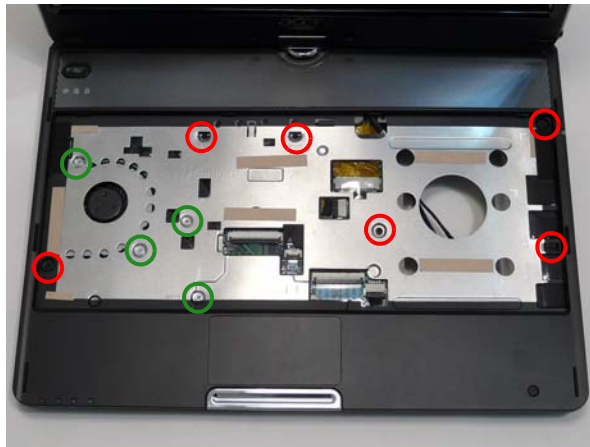

6. Remove the ten (10) screws in the upper cover.



Step	Screw	Quantity	Screw Type.
Upper Cover	M2*5 (Red Call Out)	6	
	M2*2.5 (Green Call Out)	4	

7. Pry the upper and lower covers apart at the location shown.



8. Pry the front side open.

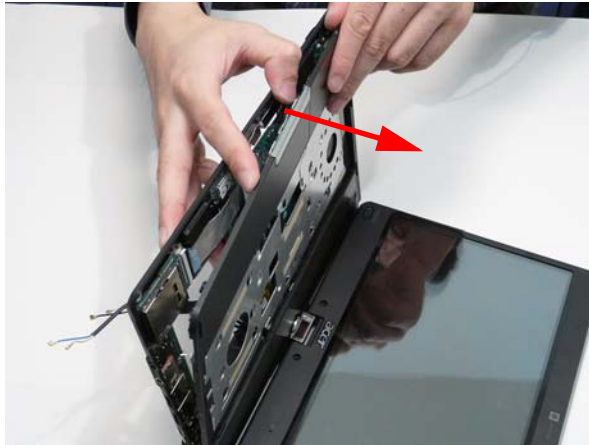

9. Pry the left side open.

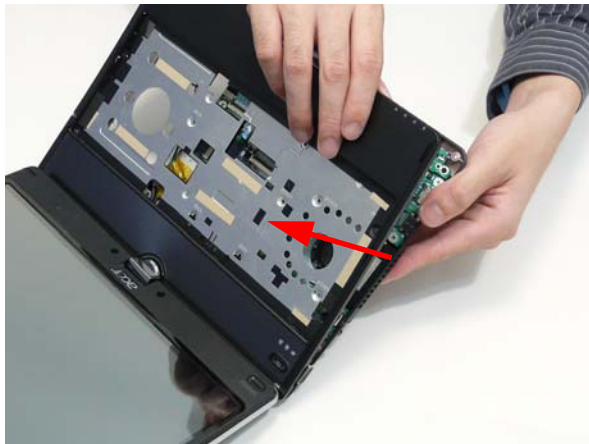

10. Pull the upper cover away.

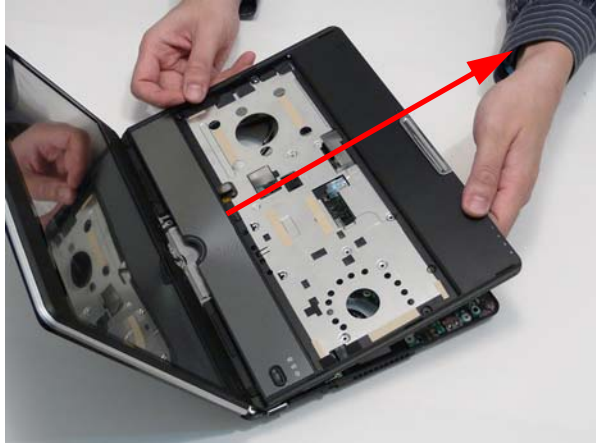

Removing the Button Board

IMPORTANT: The Touchpad Board cannot be removed individually. To replace the Touchpad Board, replace the entire Upper Cover.

1. See “Removing the Upper Cover” on page 57.
2. Unlock the button board cable.



3. Disconnect the button board cable.

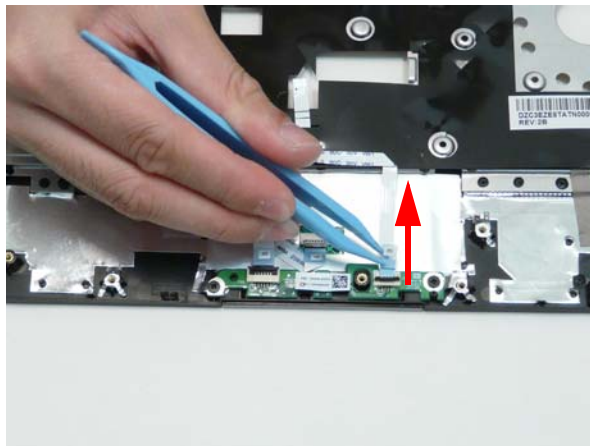

4. Pull the button board cable off the adhesive.

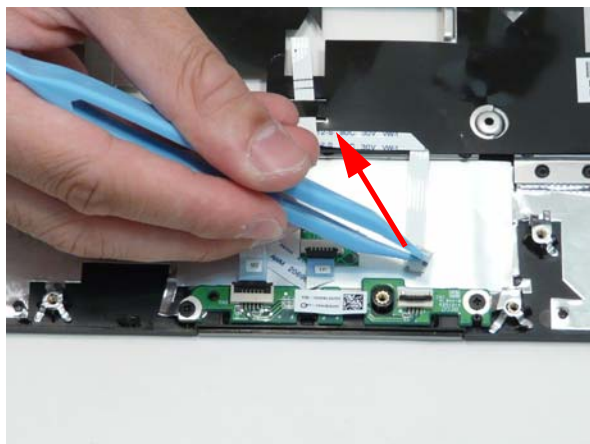

5. Remove the button board cable.

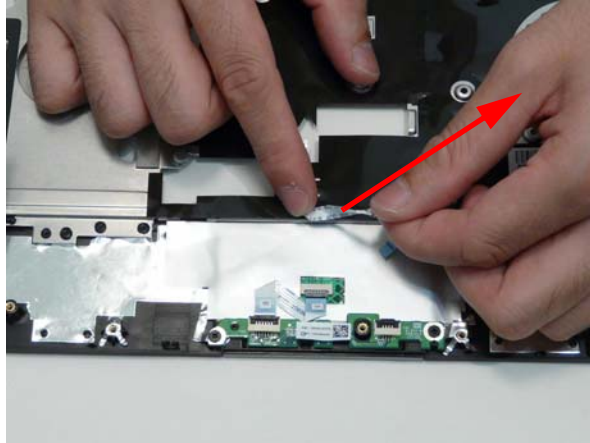

6. Unlock the touchpad cable from the button board.

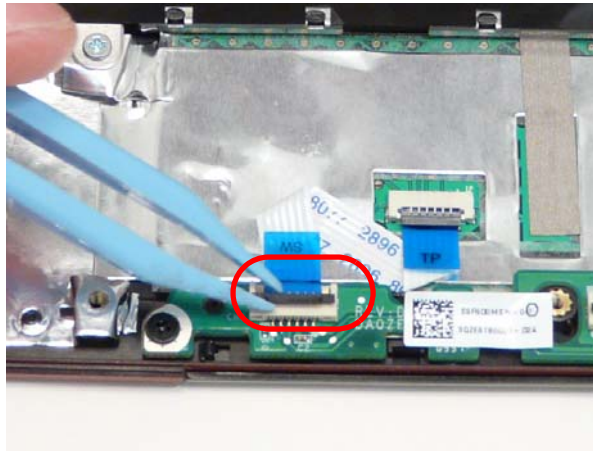

7. Disconnect the touchpad cable.

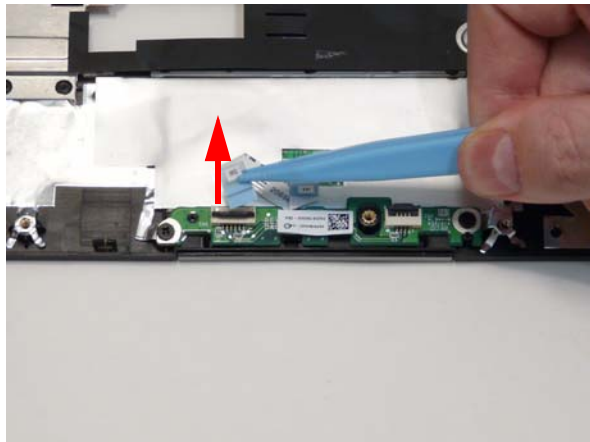

8. Pull the touchpad cable off the adhesive.

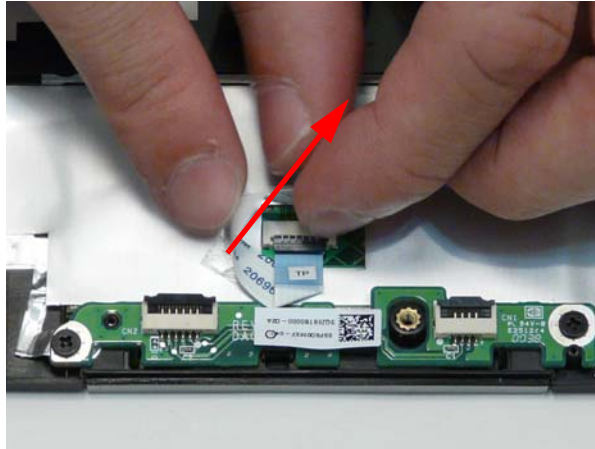

9. Unlock the touchpad cable from the touchpad.

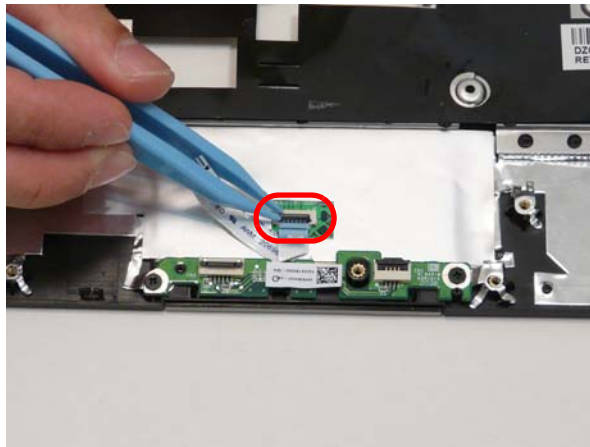

10. Remove the touchpad cable.

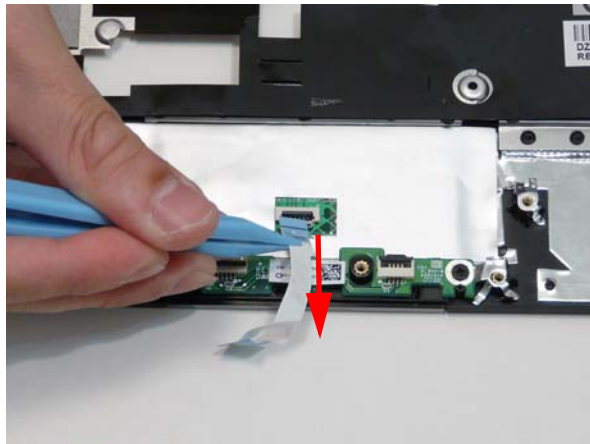

11. Remove the two (2) screws.

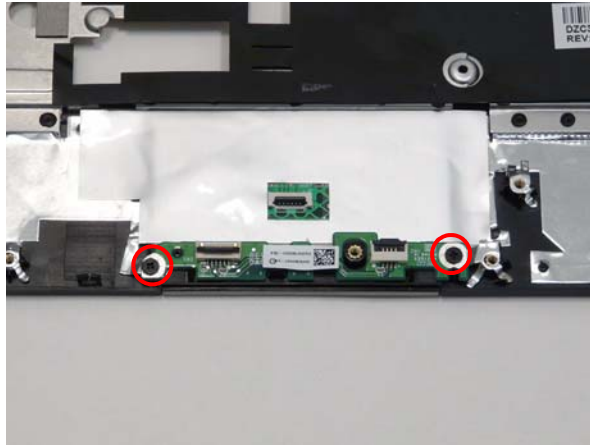

Step	Screw	Quantity	Screw Type.
Button Board	M2*3	2	

12. Remove the button board.

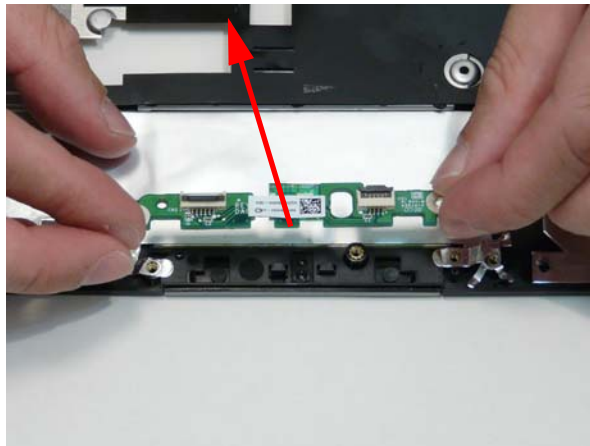

Removing the I/O Board

1. See “Removing the Upper Cover” on page 57.
2. Unlock the I/O cable I/O board connector.

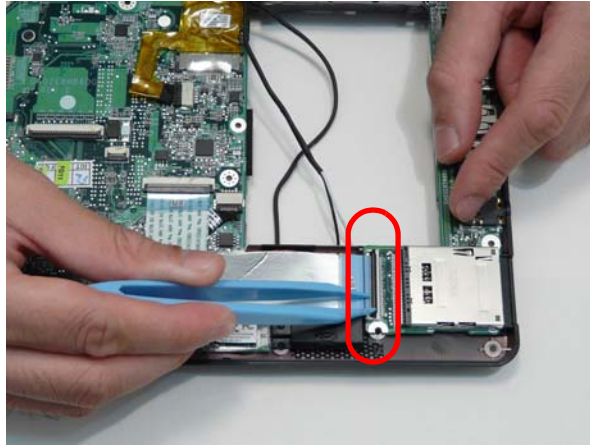

3. Disconnect the IO cable from the I/O board.

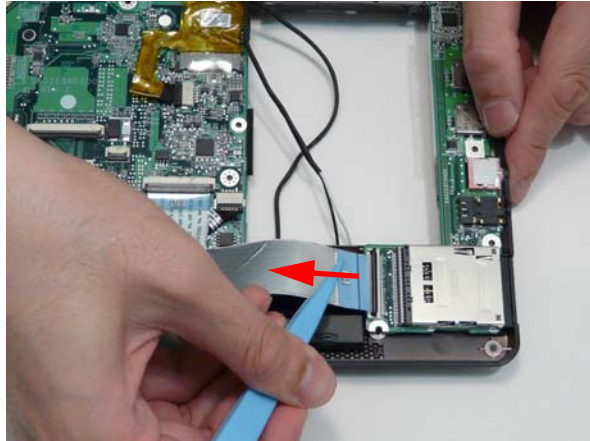

4. Unlock the I/O cable main board connector.

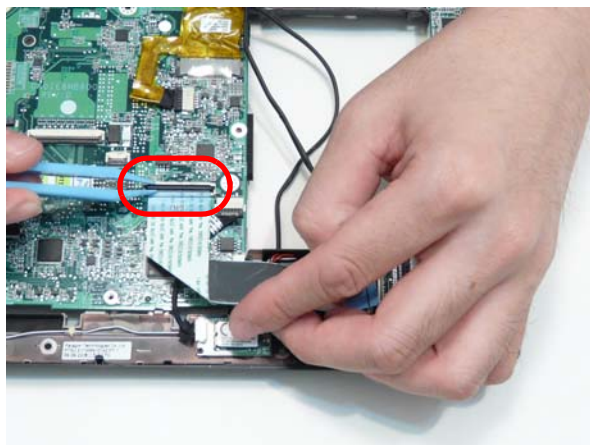

5. Remove the IO cable.

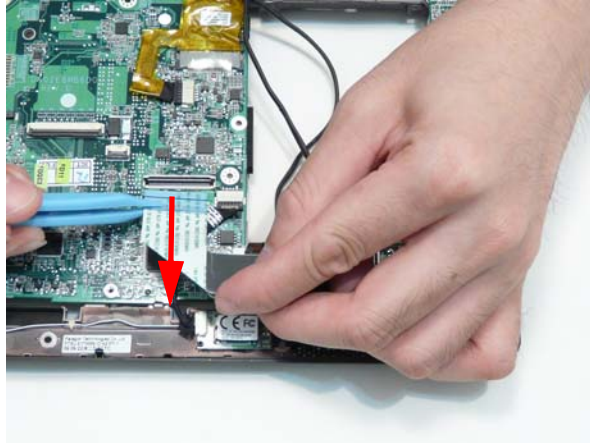

6. Turn the LCD module.



7. Remove the one (1) screw.



Step	Screw	Quantity	Screw Type.
I/O Board	M2*4	1	

8. Turn the LCD module.



9. Lift the inside edge of the I/O board and pull the I/O board away.

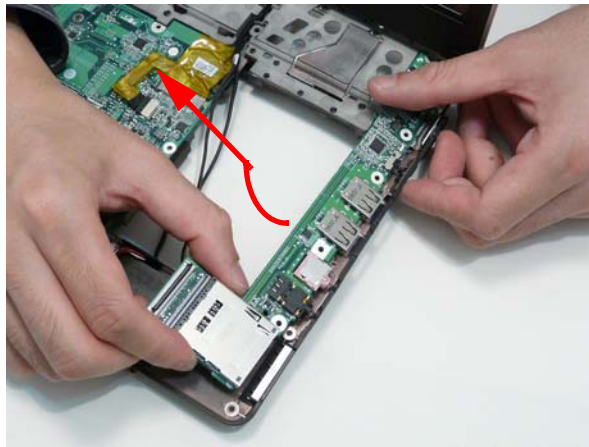

Removing the Bluetooth Module

1. See "Removing the Upper Cover" on page 57.
2. See "Removing the I/O Board" on page 65.
3. Disconnect the Bluetooth cable from the mainboard.

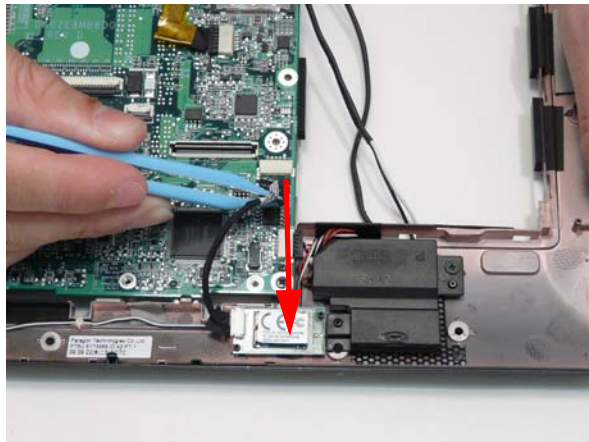

4. Disconnect the Bluetooth cable from the Bluetooth module.

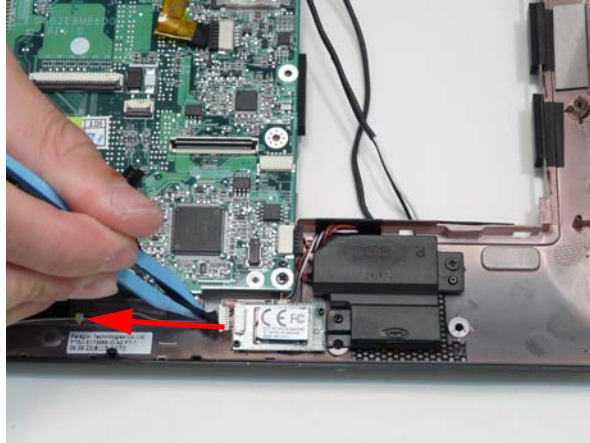

5. Pry the Bluetooth module off the adhesive and remove.

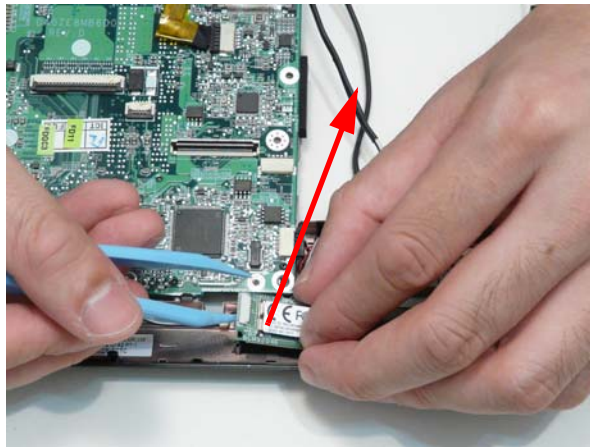

Removing the LED Board

1. See "Removing the Upper Cover" on page 57.
2. Unlock the LED cable LED board connector.

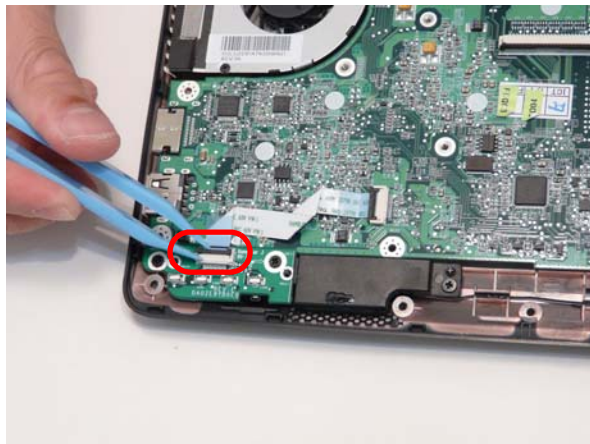

3. Disconnect the LED cable from the LED board connector.



4. Unlock the LED cable main board connector.

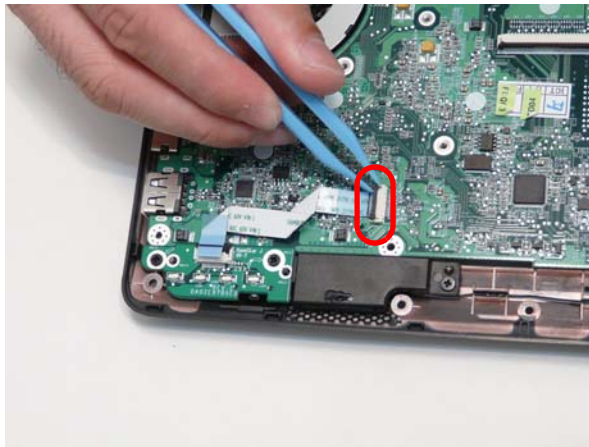

5. Remove the LED cable.

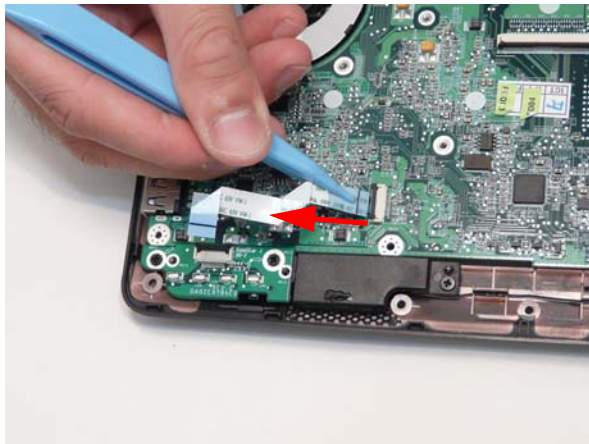

6. Remove the two (2) screws.



Step	Screw	Quantity	Screw Type.
LED Board	M2*4	2	

7. Remove the LED board.

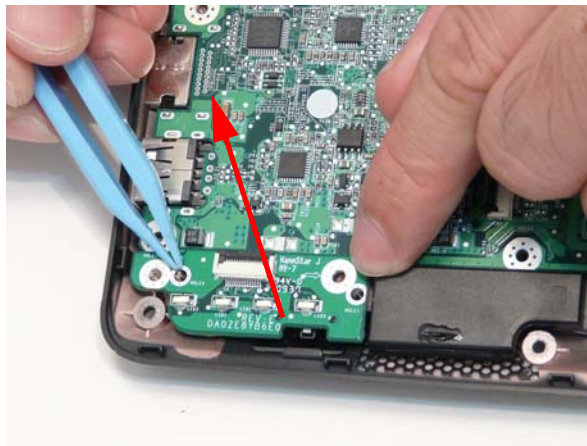

Removing the CRT Board

1. See "Removing the Upper Cover" on page 57.
2. Turn the LCD module to expose the CRT board.



3. Remove the one (1) screw.



Step	Screw	Quantity	Screw Type.
CRT Board	M2*4	1	

4. Lift the CRT board up one (1) centimetre (0.5 inch).

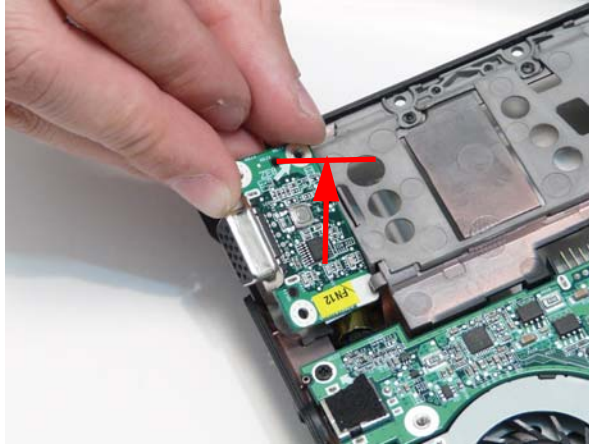

CAUTION: Do not lift too high and strain the cable and connector still attached.

5. Turn the CRT board over.

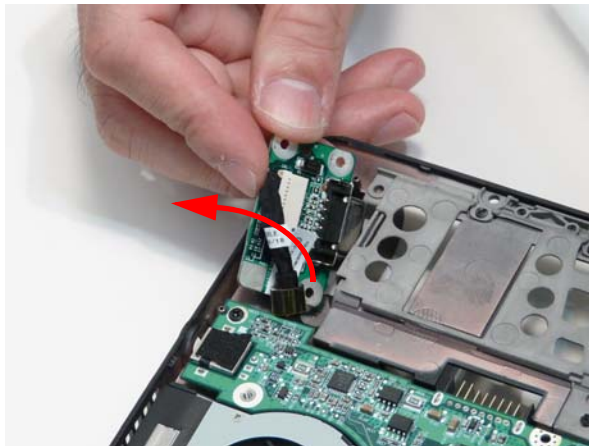

6. Remove the CRT cable.

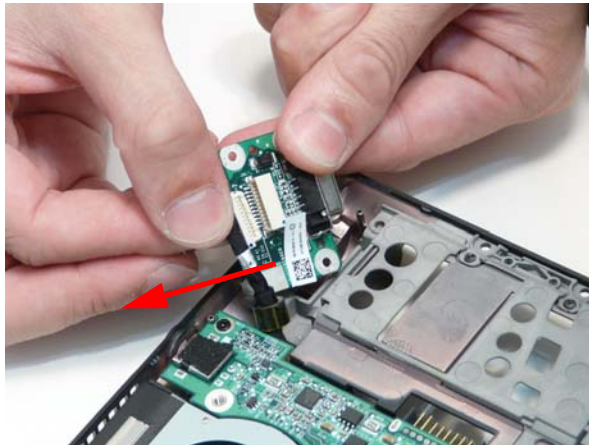

Removing the Mainboard

1. See “Removing the Upper Cover” on page 57.
2. See “Removing the I/O Board” on page 65.
3. See “Removing the Bluetooth Module” on page 67.
4. See “Removing the LED Board” on page 68.
5. See “Removing the CRT Board” on page 71.
6. Disconnect the touchscreen cable.



7. Remove the LCD connector cable clear protective cover.

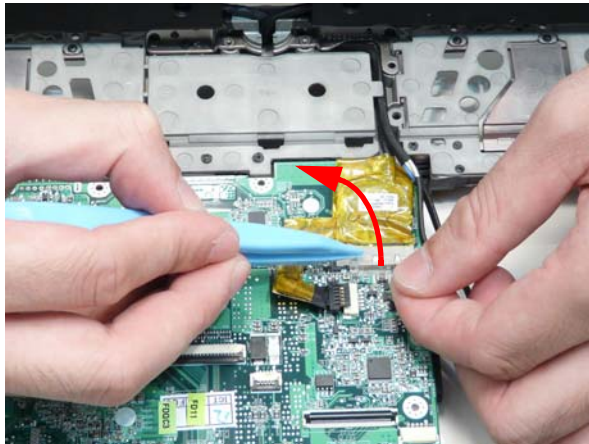

8. Disconnect the LCD cable.

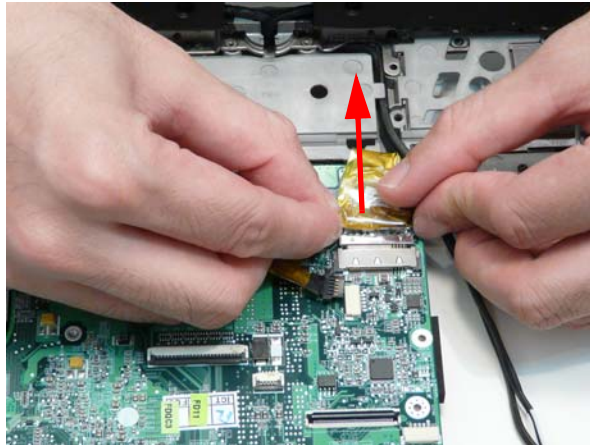

9. Disconnect the speaker cable.

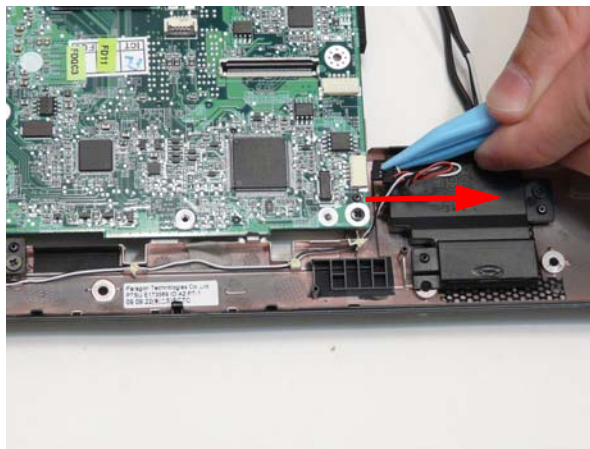

10. Remove the two (2) screws.



Step	Screw	Quantity	Screw Type.
Main Board	M2*4	2	

11. Lift up the main board from the inside edge and pull away.



12. Remove the CRT cable.

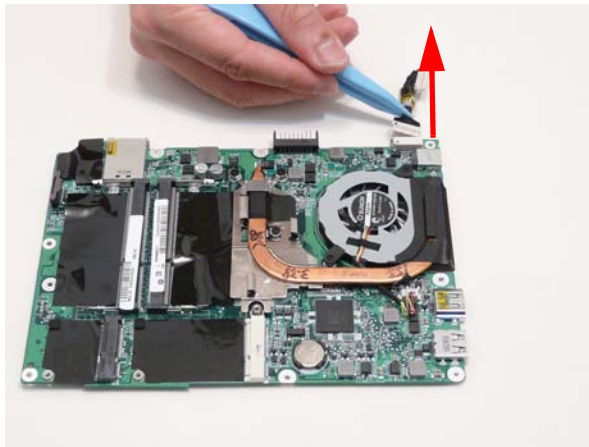

Removing the Thermal Module

1. See “Removing the Mainboard” on page 73.
2. Disconnect the thermal module cable.

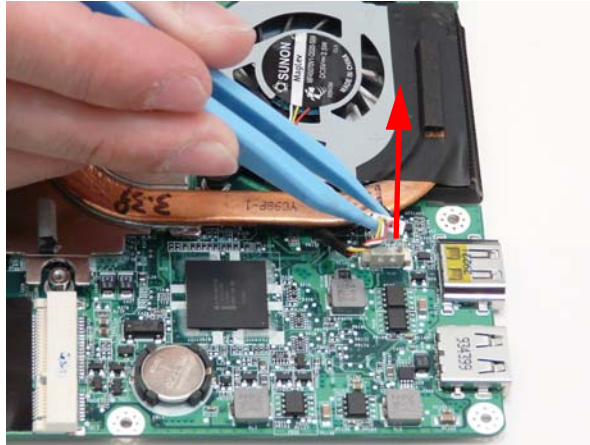

3. Loosen the five (5) captive screws. The three (3) captive screws for the CPU connection marked 1,2,3 must be loosened in order: first 3, then 2, then 1.

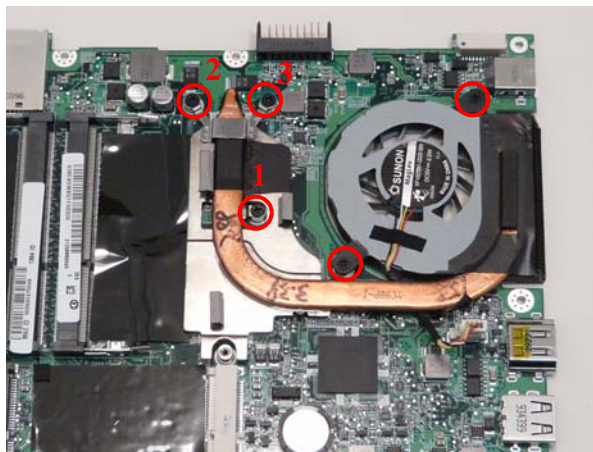

4. Remove the thermal module.

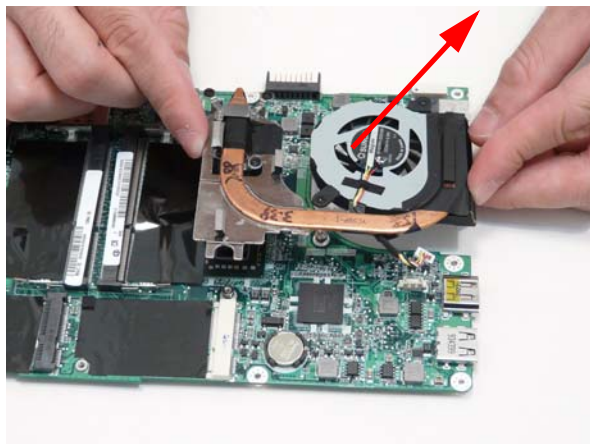

Removing the RTC Battery

1. See "Removing the Mainboard" on page 73.
2. Carefully lift the battery out of the main board.

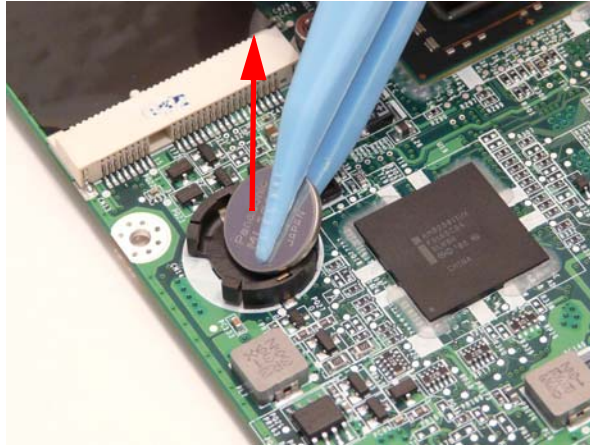

Removing the Speaker Modules

1. See "Removing the Mainboard" on page 73.
2. Remove the two (2) screws.

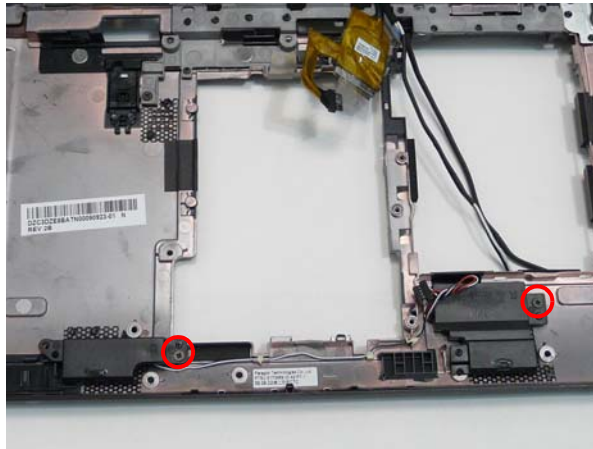

Step	Screw	Quantity	Screw Type.
Speaker	M2*3	2	

3. Grasp the speaker housings and remove the speaker module.

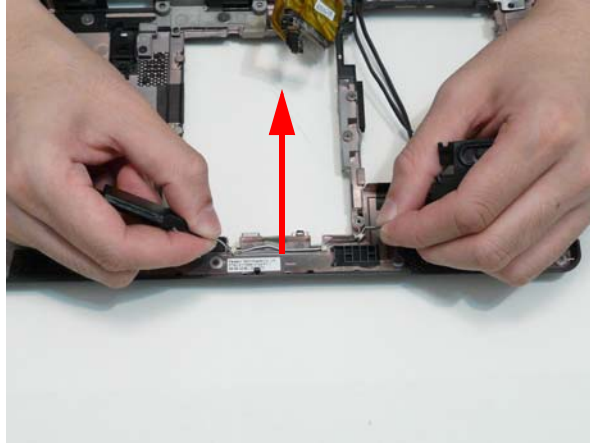

Removing the LCD Module

1. See "Removing the Mainboard" on page 73.
2. Lift the antenna cable (i) and the LCD cable (ii) away from the retention guide hook.

i)

ii)

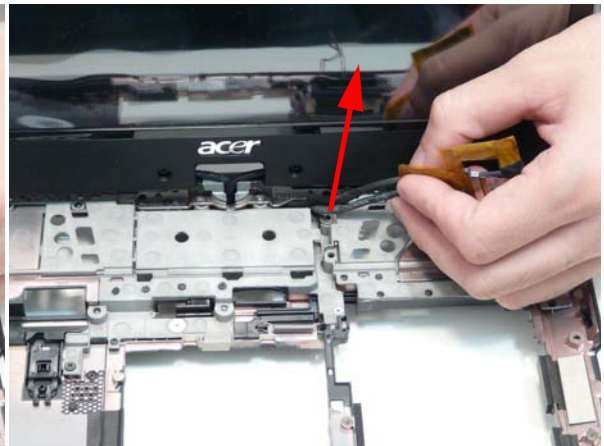
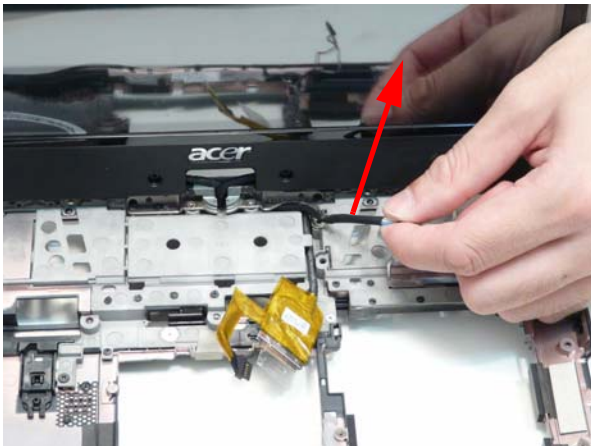

3. Turn the LCD module ninety (90) degrees.



4. Remove the five (5) screws.



Step	Screw	Quantity	Screw Type.
LCD Module	M2*5	5	

5. Remove the LCD module.

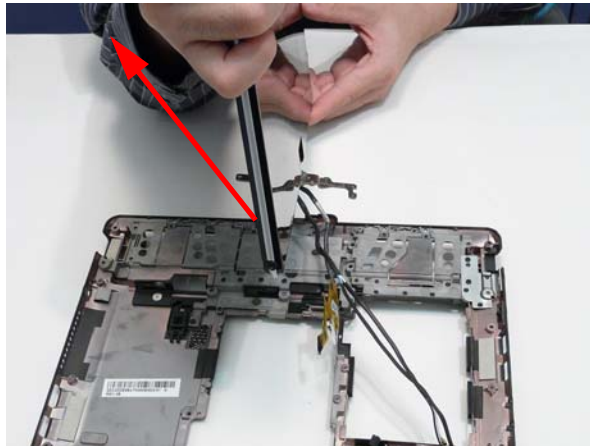

LCD Module Disassembly Process

IMPORTANT: Cable paths and positioning may not represent the actual model. During the removal and replacement of components, ensure all available cable channels and clips are used and that the cables are replaced in the same position.

NOTE: The product previews seen in the disassembly procedures may not represent the final product color or configuration.

LCD Module Disassembly Flowchart

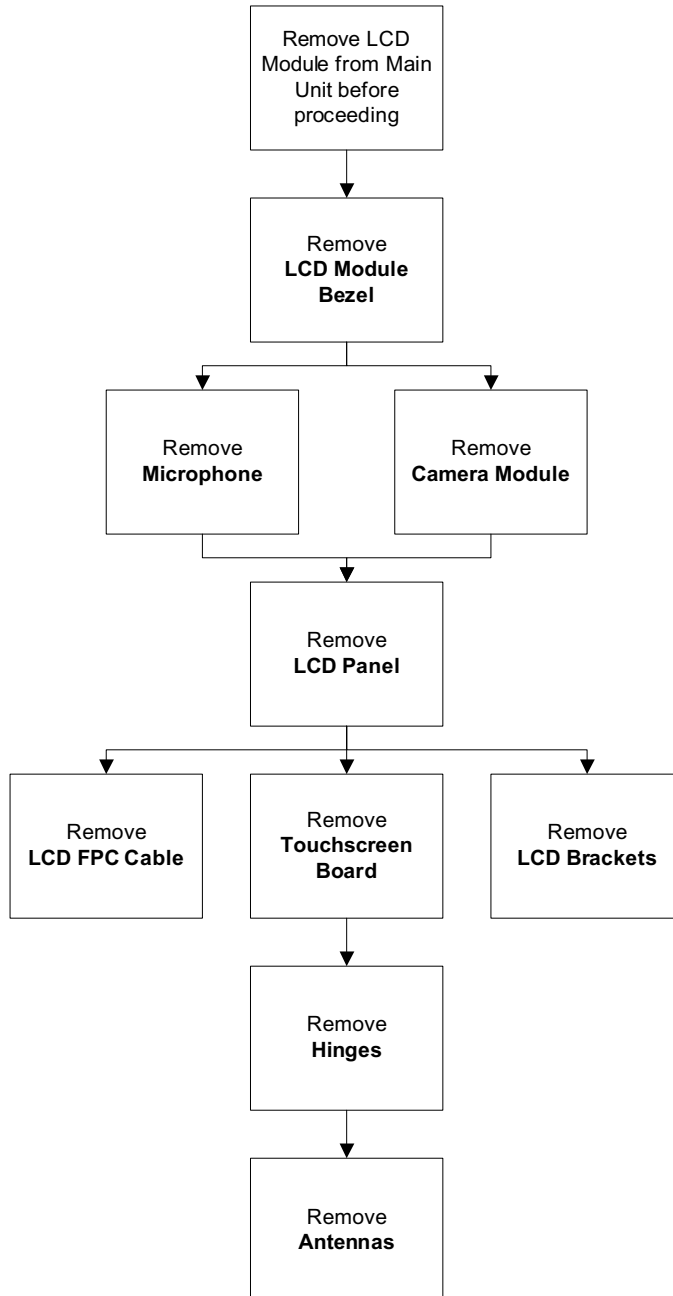

Screw List

Step	Screw	Quantity	Part No.
LCD Bezel	M2*5	2	86.TG607.004
LCD Panel	M2*4	4	86.W0107.003
LCD Brackets	M2*2.5	4	86.TPK07.001
Touchscreen Board	M2*4	2	86.W0107.003
Hinge	M2*4	3	86.W0107.003

Removing the LCD Bezel

1. See "Removing the LCD Module" on page 78.
2. Remove the stylus.



3. Remove the screw covers



4. Remove the two (2) screws.



Step	Screw	Quantity	Screw Type.
LCD Bezel	M2*5	2	

5. Pry up the bezel from the bottom edge.



6. Pry up the bezel sides.



7. Pry up the bezel top edge and remove.

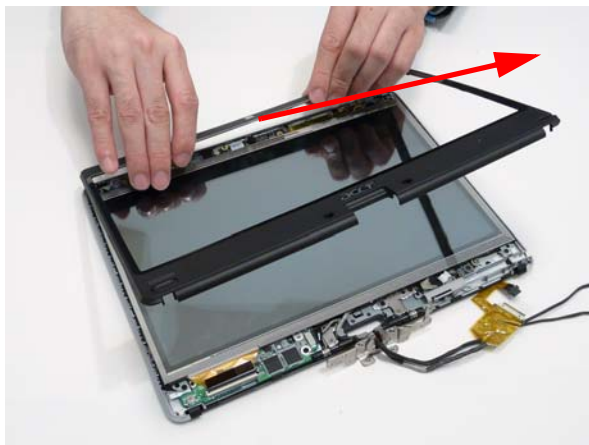

Removing the Camera Board

1. See "Removing the LCD Bezel" on page 82.
2. Pry up the camera board from the adhesive.

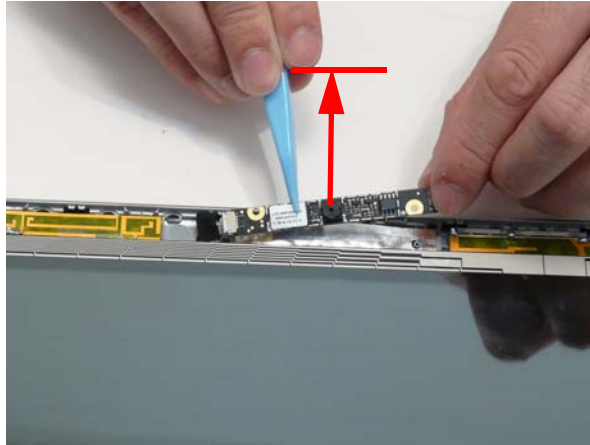

3. Disconnect the camera cable.

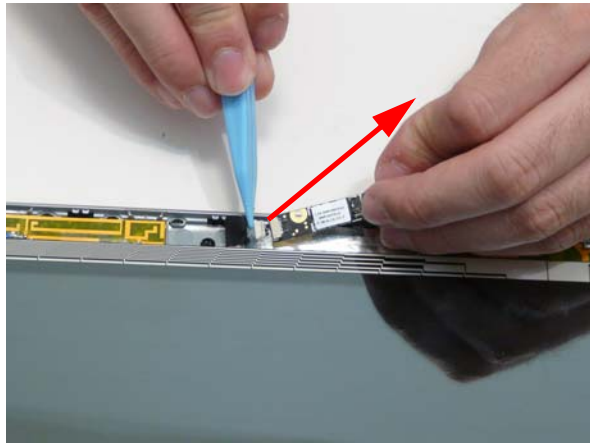

Removing the Microphone

1. See “Removing the LCD Bezel” on page 82.
2. Disconnect the microphone cable.

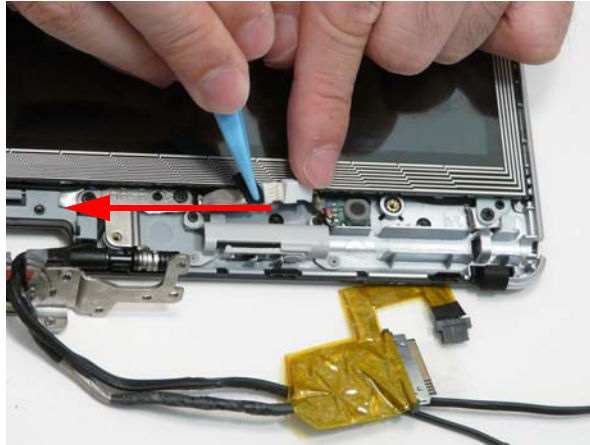

3. Pry up the microphone from the adhesive.



Removing the LCD Panel

1. See “Removing the Camera Board” on page 85.
2. See “Removing the Microphone” on page 86.

WARNING: The edges of the touchscreen surface are sharp and care should be taken when handling the panel.

3. Unlock the touchscreen FCP.

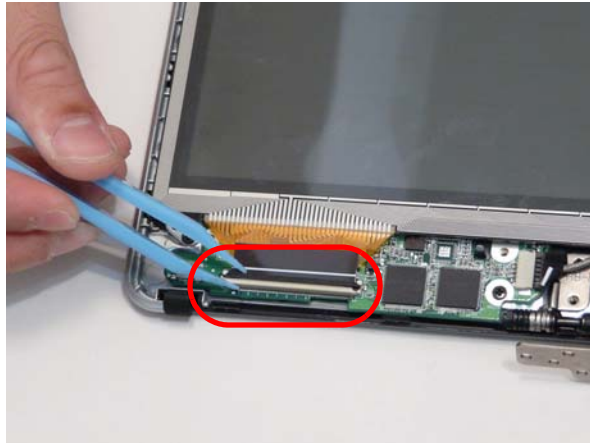

4. Disconnect the touchscreen cable.

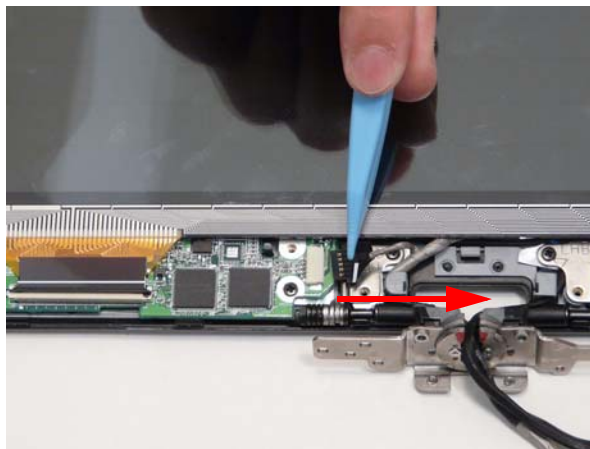

5. Remove the four (4) screws.



Step	Screw	Quantity	Screw Type.
Touchscreen Board	M2*4	4	

6. Lift up the panel (1) and disconnect the touchscreen FCP (2).



7. Remove the LCD cable from the retention guide hook.



8. Remove the LCD panel.

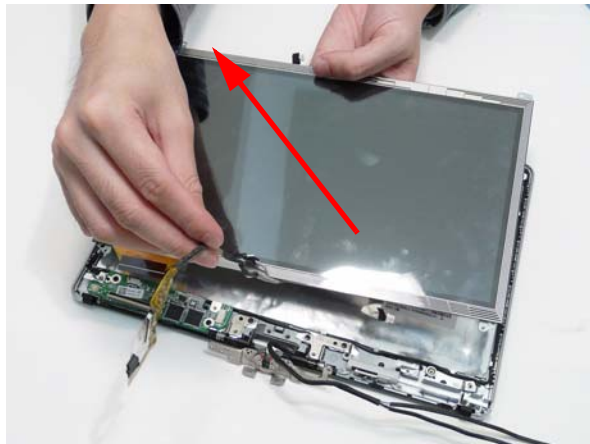

Removing the LCD Cable

1. See "Removing the Microphone" on page 86.
2. Turn the LCD panel face down on a dry clean soft surface.

3. Pull the camera cable from the adhesive.

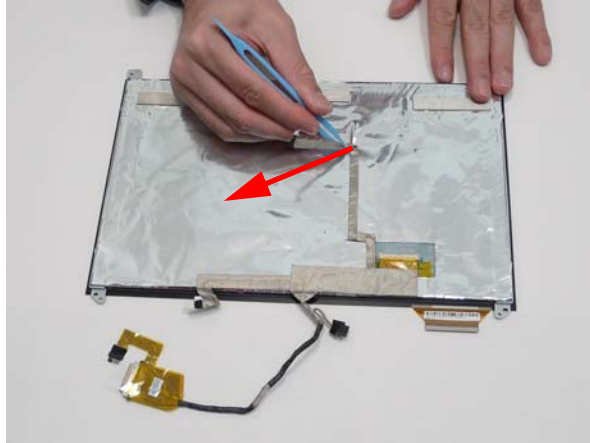

4. Lift up the LCD connector clear protective cover.

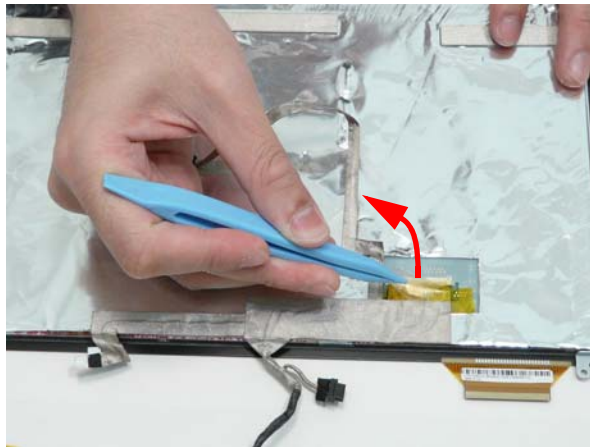

5. Disconnect the LCD connector.

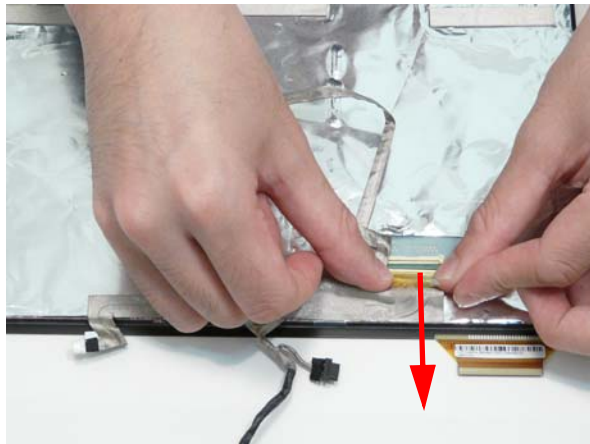

-
6. Pull up the LCD cable from the adhesive.

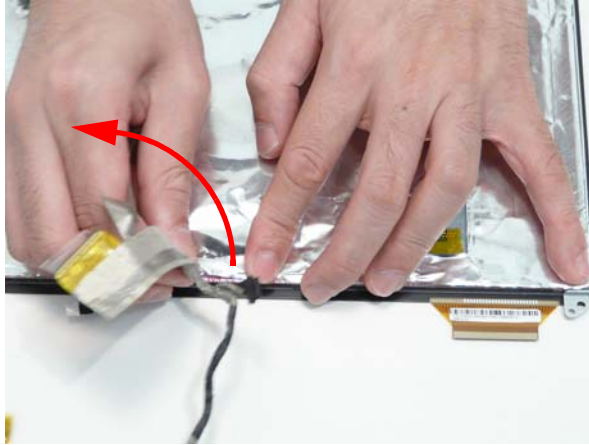

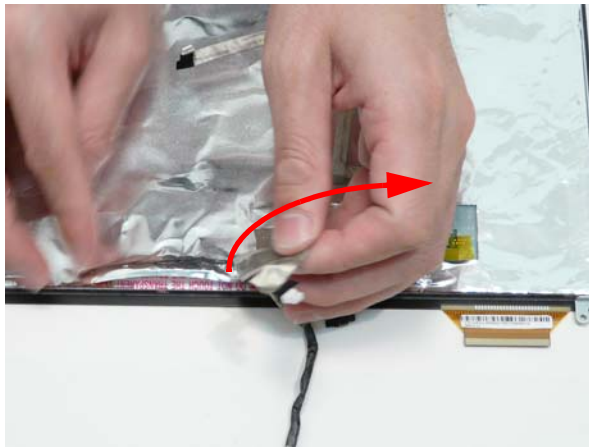

7. Pull the touchscreen cable from the adhesive.

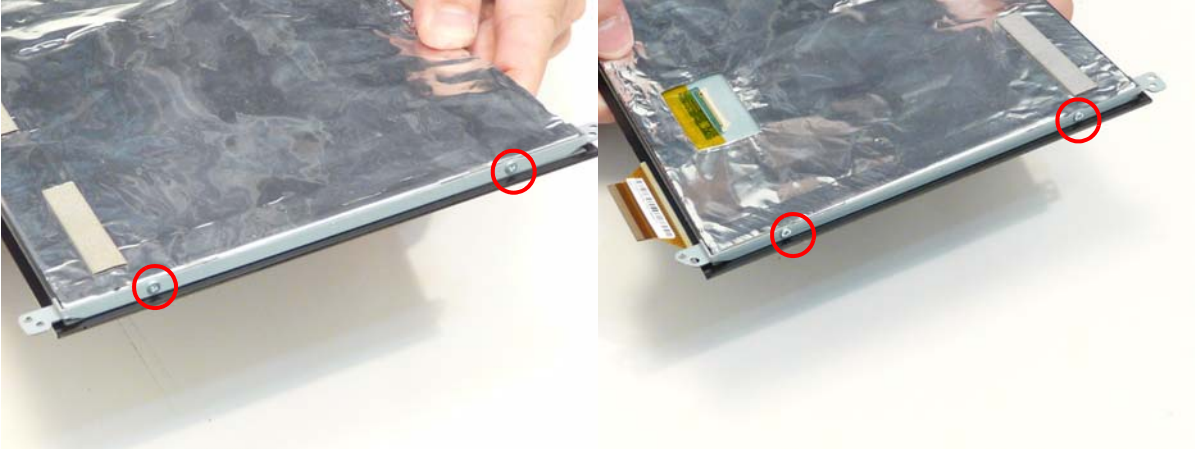

Removing the LCD Brackets

1. See "Removing the Microphone" on page 86.
2. Remove the four (4) screws from the left and right brackets.



Step	Screw	Quantity	Screw Type.
LCD Panel Brackets	M2*2.5	4	

3. Remove the brackets.



Removing the Touchscreen Board

- 1. See "Removing the LCD Panel" on page 86.
- 2. Remove the two (2) screws.

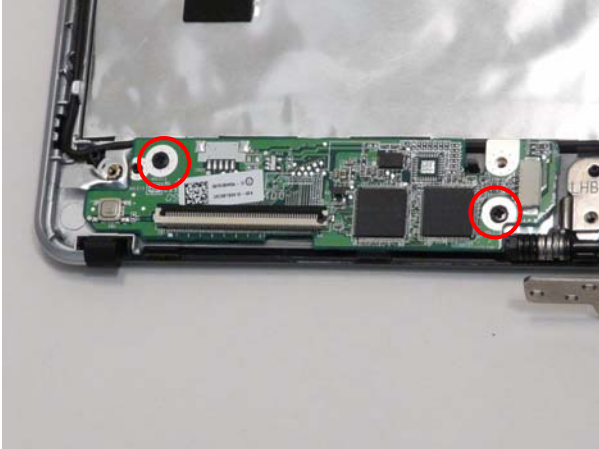

Step	Screw	Quantity	Screw Type.
Touchscreen Board	M2*4	2	

- 3. Remove the touchscreen board.

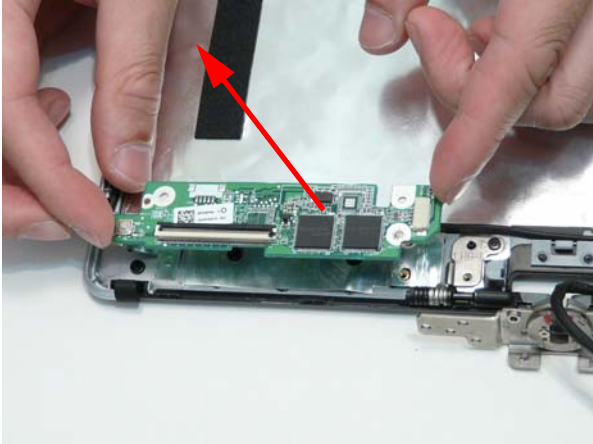

Removing the Hinge

1. See "Removing the LCD Panel" on page 86.
2. Remove the three (3) screws.

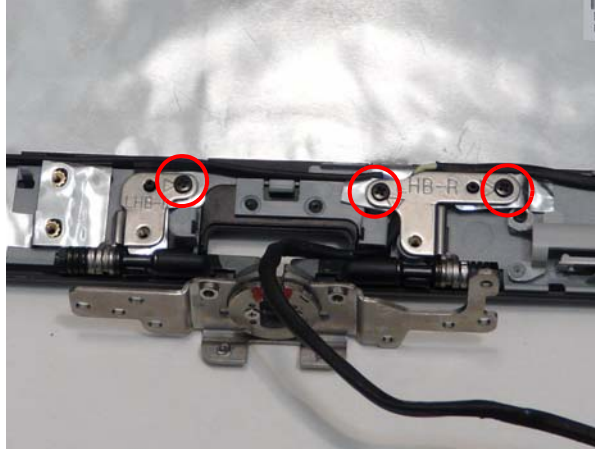

Step	Screw	Quantity	Screw Type.
Hinge	M2*3	3	

3. Remove the hinge.

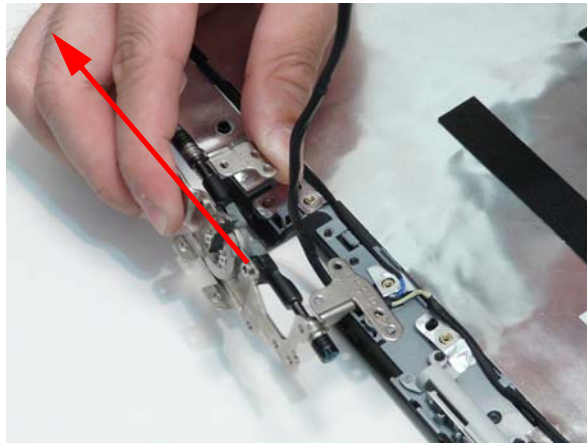

Removing the Antennas

1. See “Removing the Microphone” on page 86.
2. See “Removing the Touchscreen Board” on page 92.
3. See “Removing the Hinge” on page 93.
4. Peel the antenna foil off the cover.

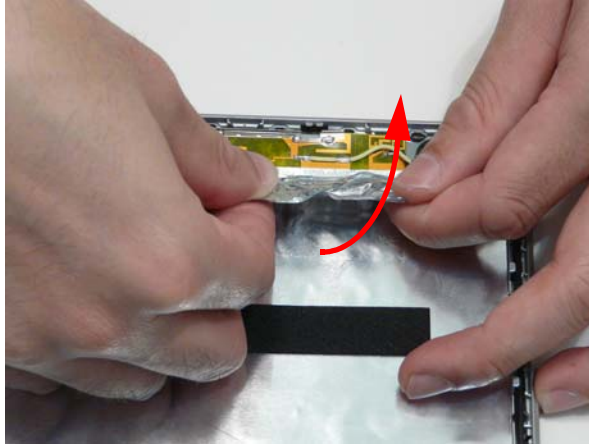

5. Peel the antenna off the adhesive.



6. Remove the antenna cable from the retention guide hooks.

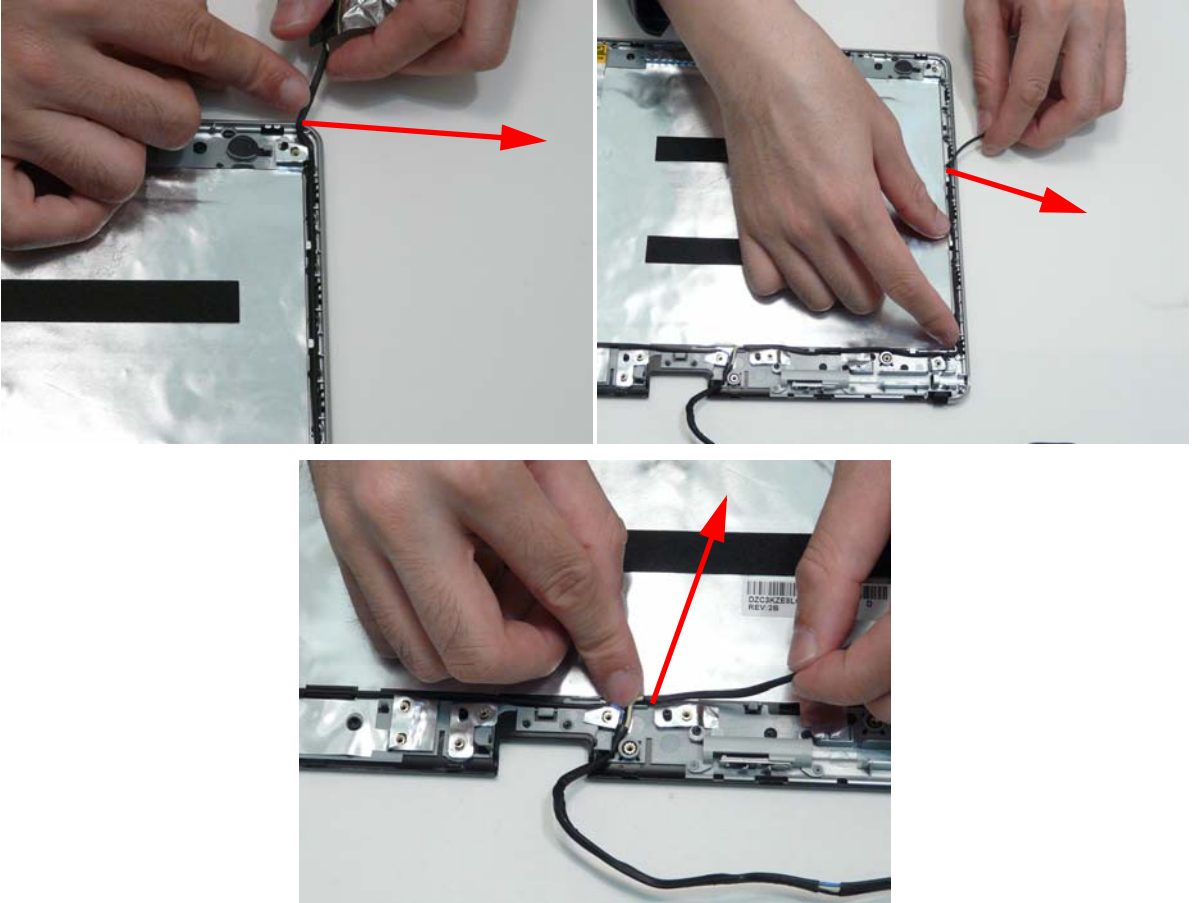

7. Peel the antenna foil off the cover.

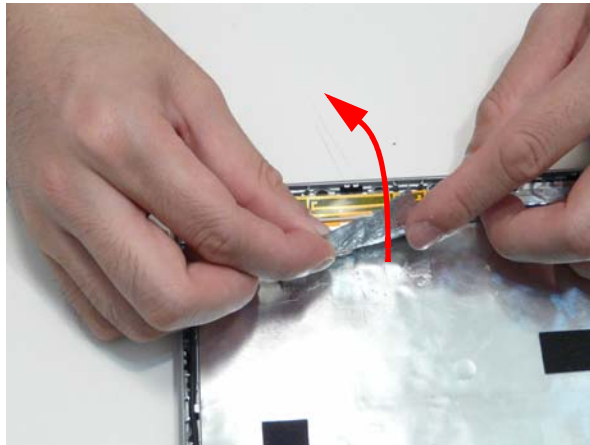

8. Peel the antenna off the adhesive.

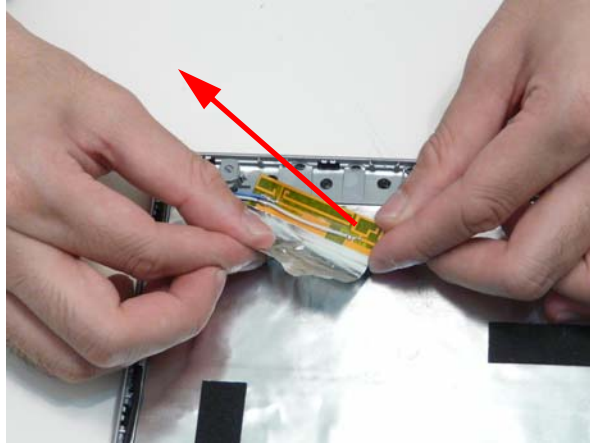

9. Remove the antenna cable from the retention guide hooks.

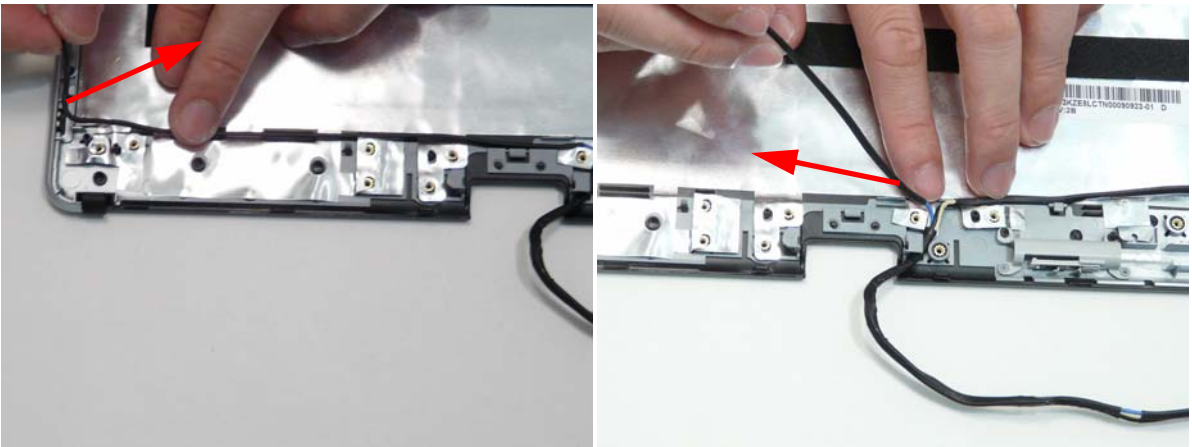

10. Remove both antenna cables from the cover.

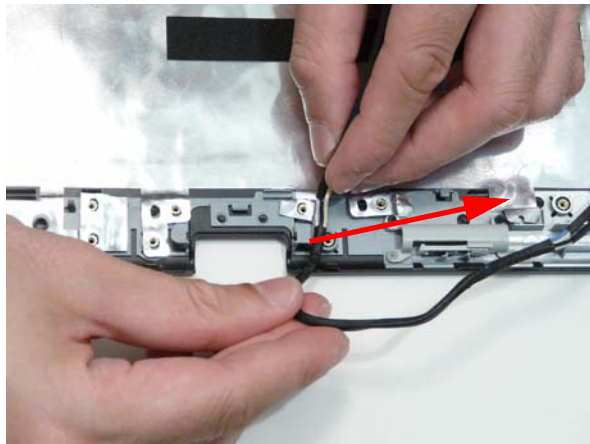

LCD Reassembly Procedure

Replacing the Antennas

1. Lay the two (2) cables under the retention guide exit hook.

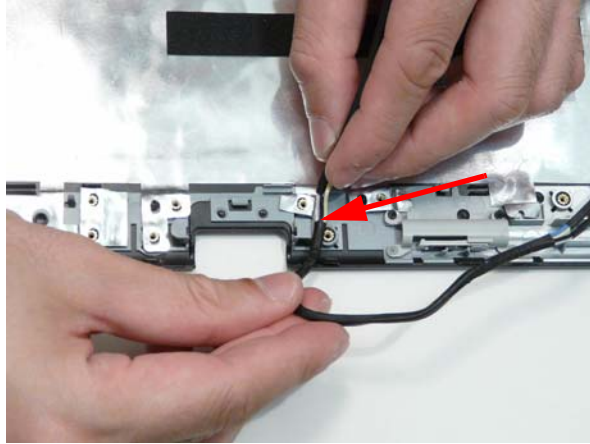

2. Lay the left side cable under the retention guide hooks.

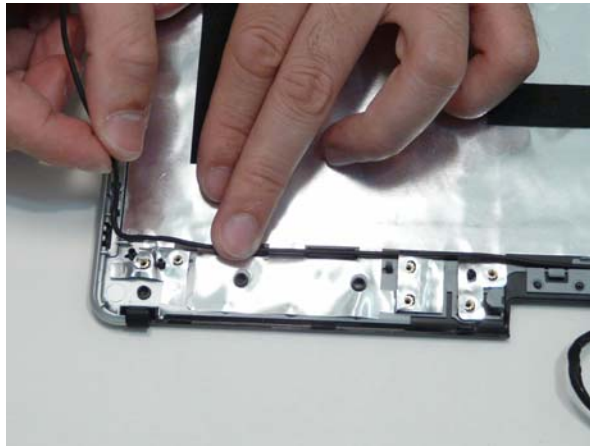

3. Adhere the left antenna pad (black cable) to the cover.

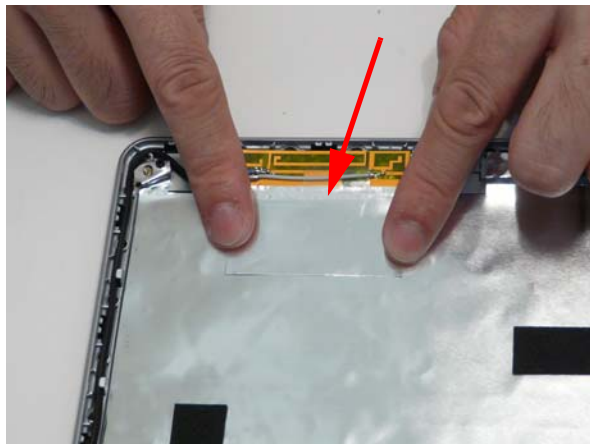

4. Lay the right side cable under the retention guide hooks.

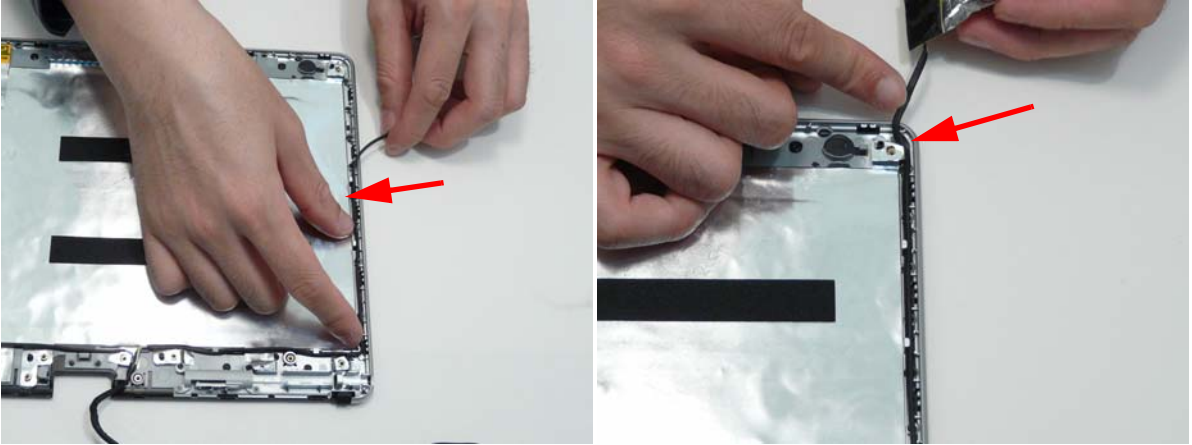

5. Adhere the right side antenna pad (yellow cable) to the cover.

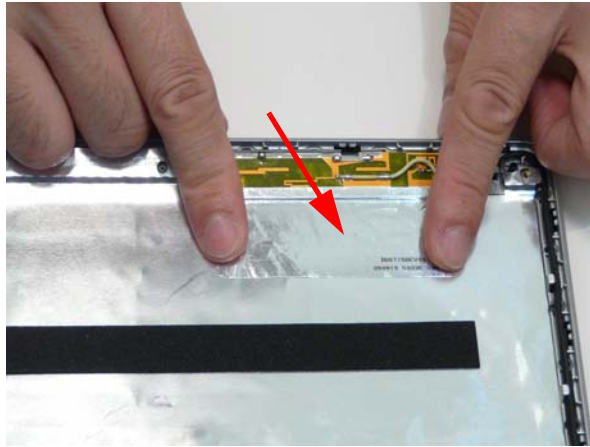

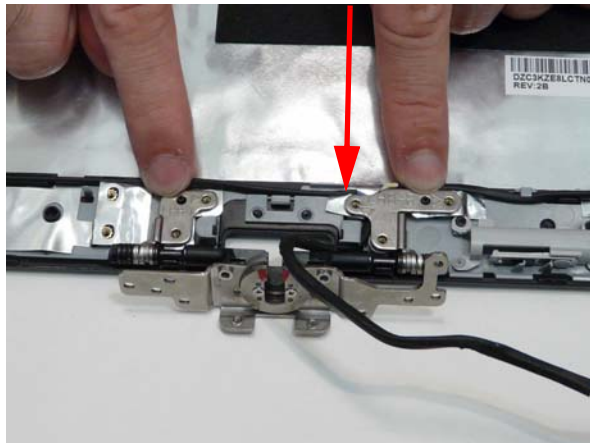

Replacing the Hinge

1. Place the hinge on the cover.

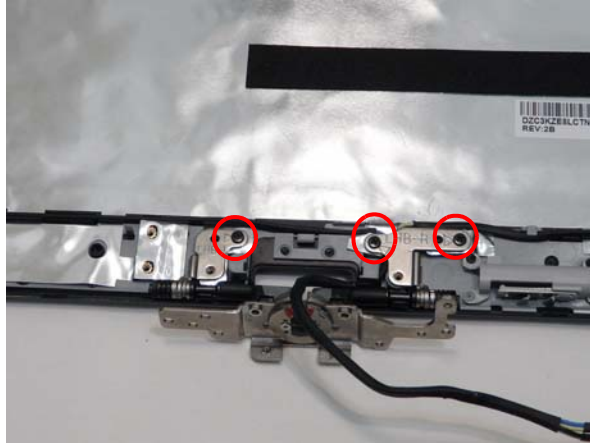

2. Replace the three (3) screws.



Step	Screw	Quantity	Screw Type.
Hinge	M2*3	3	

Replacing the Touchscreen Board.

1. Place the touchscreen board onto the cover.

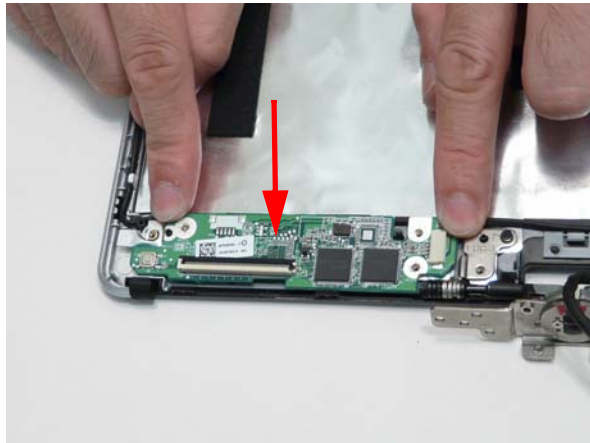

2. Replace the two (2) screws.



Step	Screw	Quantity	Screw Type.
Touchscreen Board	M2*4	2	

Replacing the LCD Brackets

1. Place the two (2) brackets on the panel paying attention to the correct orientation.



2. Replace the four (4) screws.



Step	Screw	Quantity	Screw Type.
LCD Panel Brackets	M2*2.5	4	

Replacing the LCD Cable

1. Adhere the touchscreen cable to the panel.

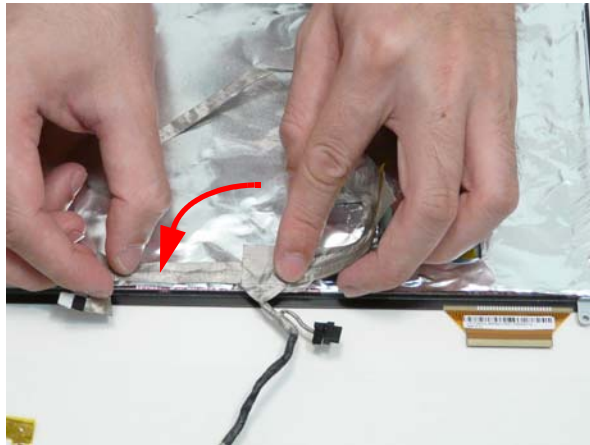

-
2. Adhere the LCD cable to the panel.



3. Connect the LCD connector to the panel.

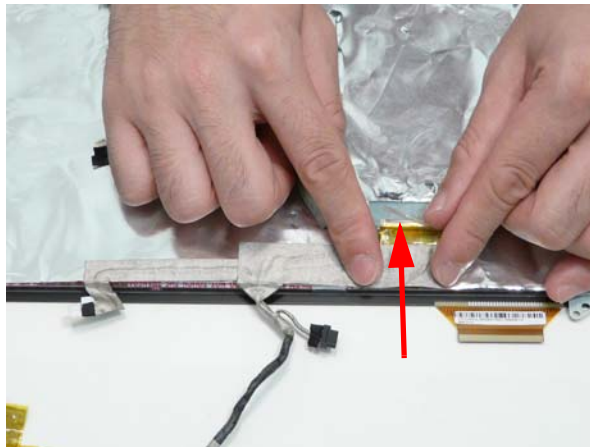

4. Adhere the clear protective cover over the LCD connector.

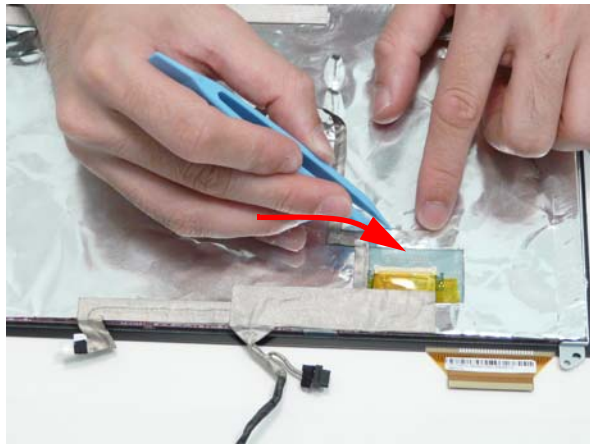

5. Adhere the camera cable to the panel.

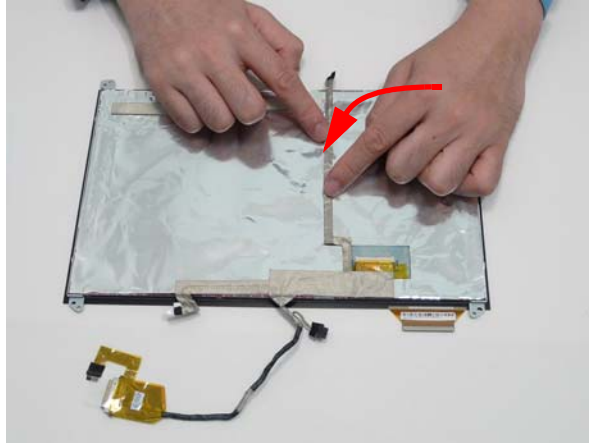

Replacing the LCD Panel

1. Lay the LCD cable first through the hinge.

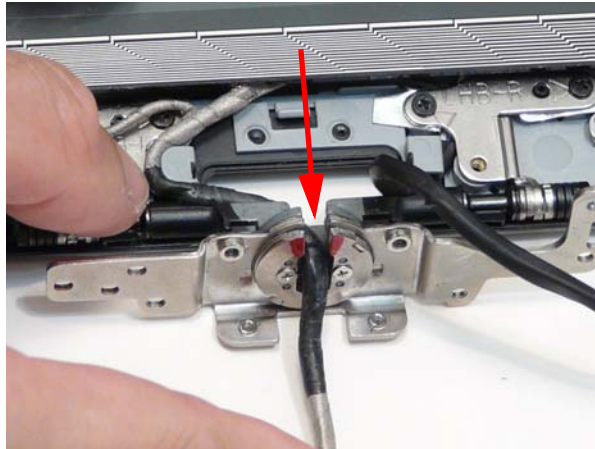

2. Lay the antenna cable through the hinge.

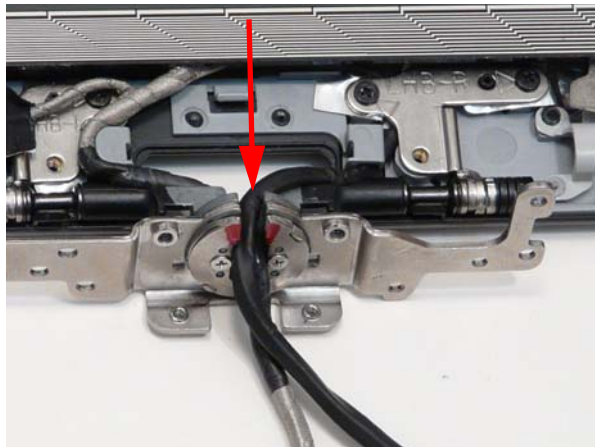

3. Connect the touchscreen FCP (1) and lay the panel down in the cover (2).



4. Replace the four (4) screws.



Step	Screw	Quantity	Screw Type.
LCD Panel	M2*4	4	

5. Connect the touchscreen cable.

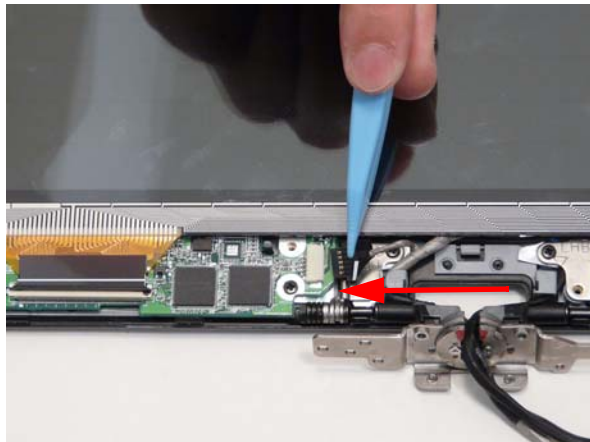

6. Lock the touch screen FCP.

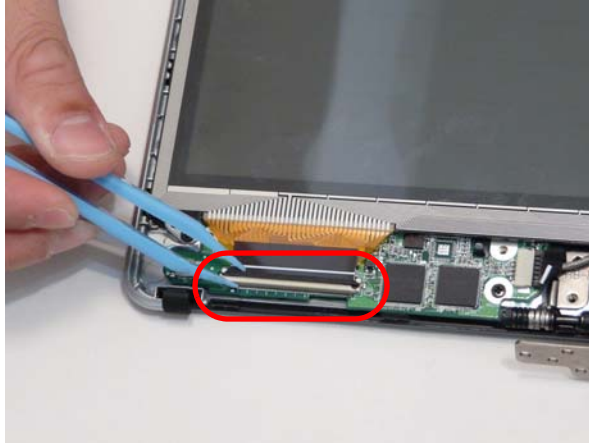

Replacing the Microphone.

1. Adhere the microphone to the cover.



2. Connect the microphone cable.

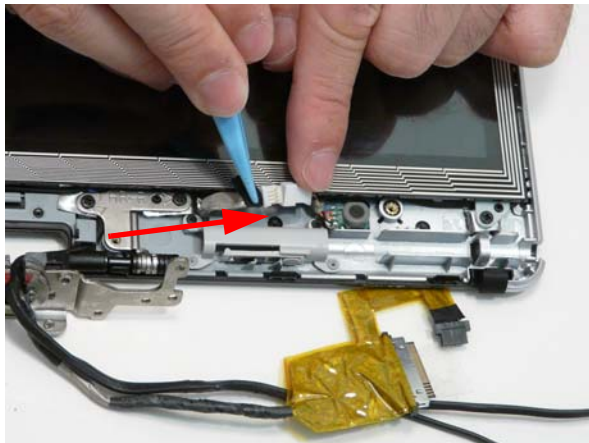

3. Make sure the cable tie is tucked securely under the panel.

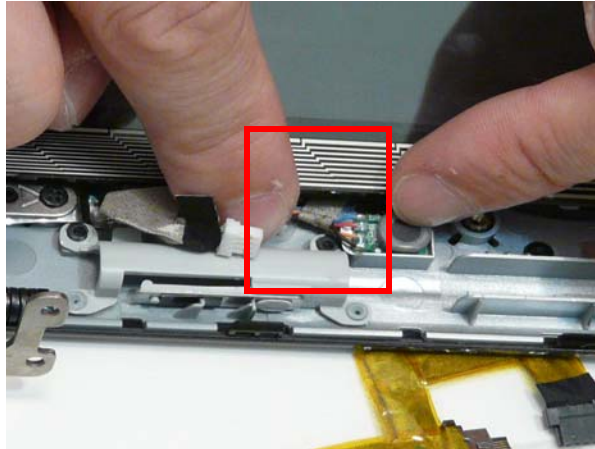

Replacing the Camera Board

1. Connect the camera board to the connector.

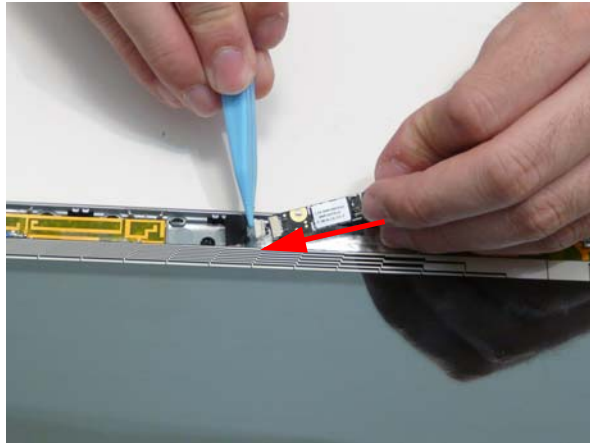

2. Adhere the camera board to the cover.

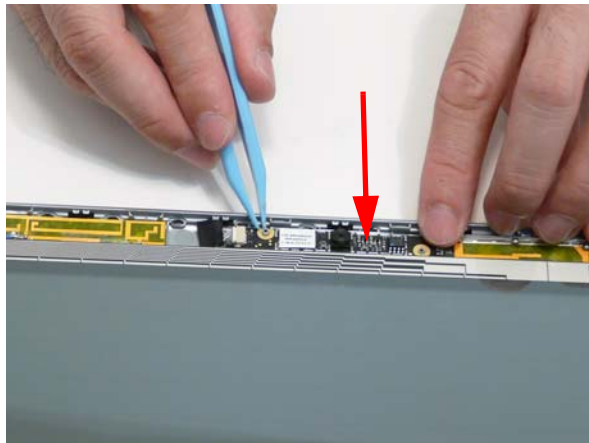

Replacing the LCD Bezel

1. Place the bezel on the cover.



2. Press down on the bezel top edge.



3. Press down the bezel sides.



4. Press down the bezel bottom edge.



5. Replace the two screws.



Step	Screw	Quantity	Screw Type.
LCD Bezel	M2*5	2	

6. Replace the screw covers.



7. Insert the stylus.



Main Unit Reassembly Process

Replacing the LCD Module

- 1. Lay the cables into the retention guides. The LCD cable first, then antenna cable on top.

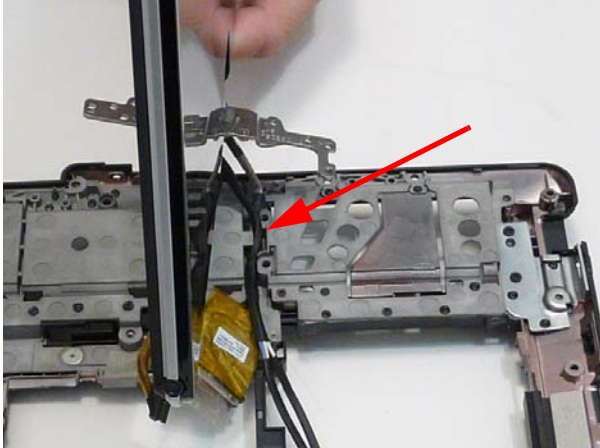

- 2. Replace the five screws (5).

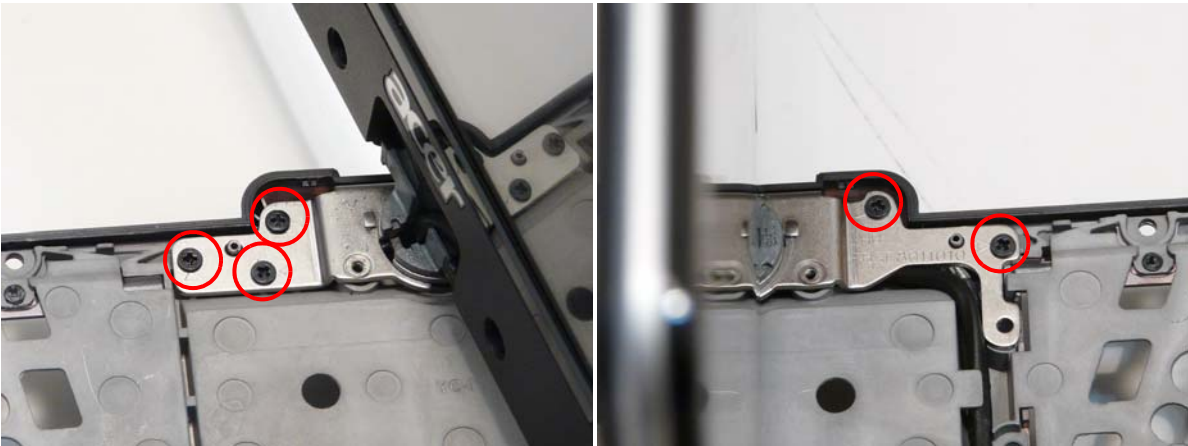

Step	Screw	Quantity	Screw Type.
LCD Module	M2*4	5	

3. Turn the LCD module.

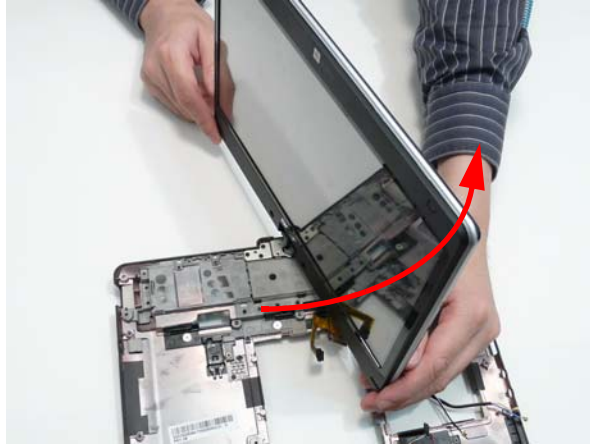

4. Lay the LCD cable in the retention guide.

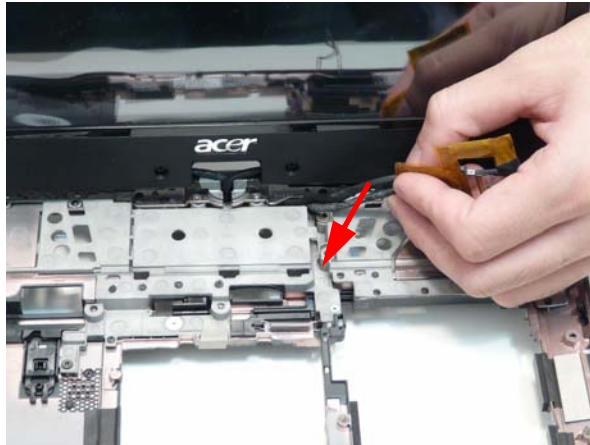

5. Lay the antenna cable in the retention guide.

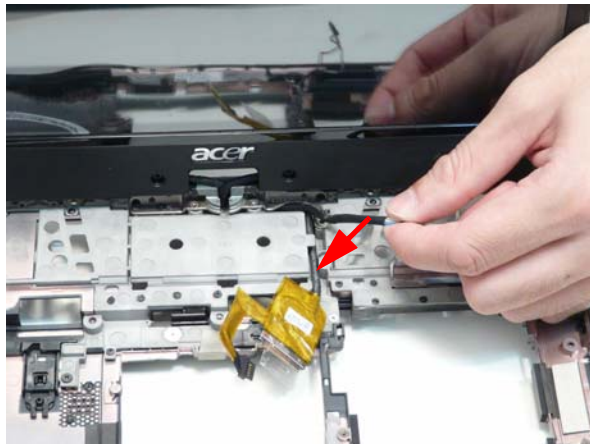

Replacing the RTC Battery

1. Push the RTC battery into the holder.

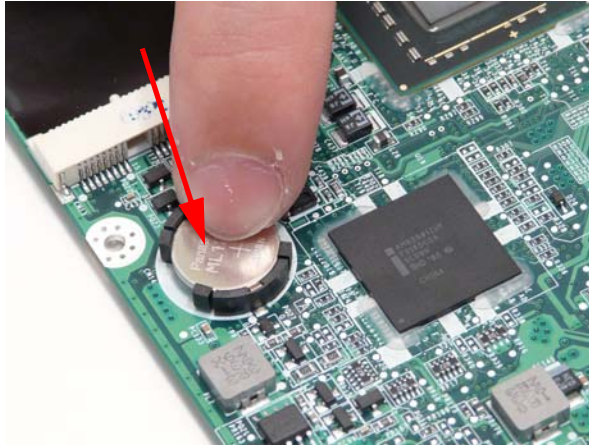

Replacing the Thermal Module

IMPORTANT: Ensure all heat pads are in place before replacing the Thermal Module.

The following thermal pads are approved for use:

- Eapus XR-PE
1. Remove all traces of thermal grease or pad adhesive from the CPU and thermal module using a lint-free cloth or cotton swab and Isopropyl Alcohol, Acetone, or other approved cleaning agent.
 2. Place the thermal module on the main board.

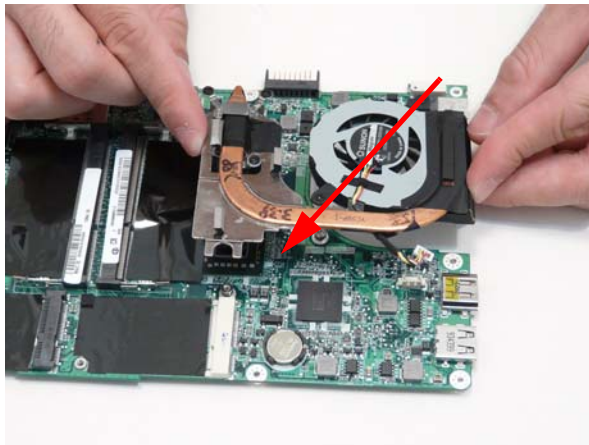

3. Tighten the five (5) captive screws. First tighten the CPU captive screws in order: 1 then 2 then 3. Then tighten the two (2) other screws.

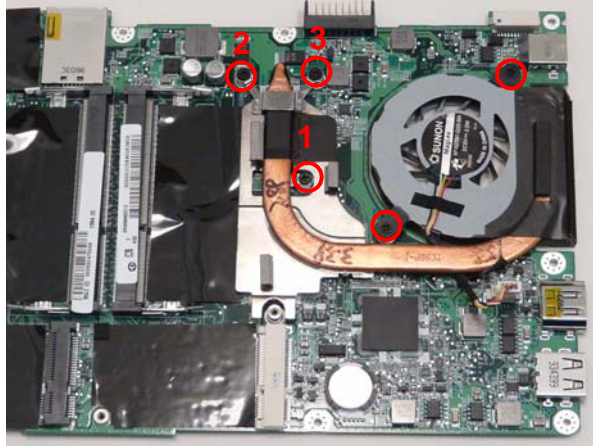

4. Connect the thermal module cable.

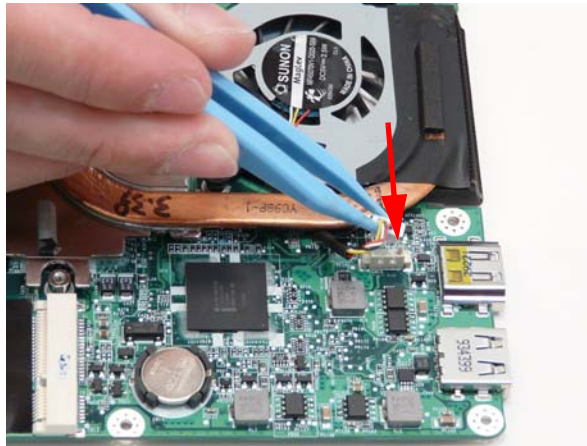

Replacing the Speakers.

1. Lay the speaker cables into the retention guides and apply glue on the retention guide locations.

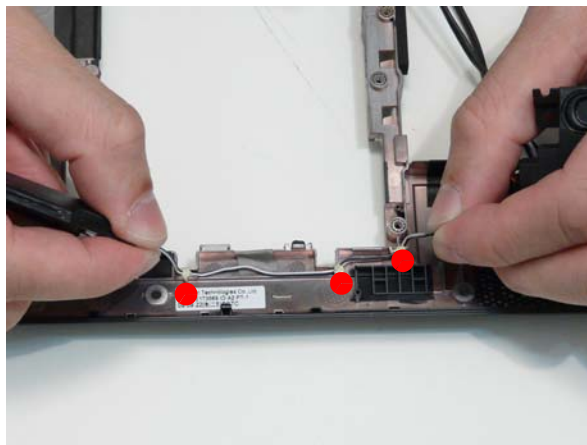

2. Place the speaker modules onto the bottom cover.

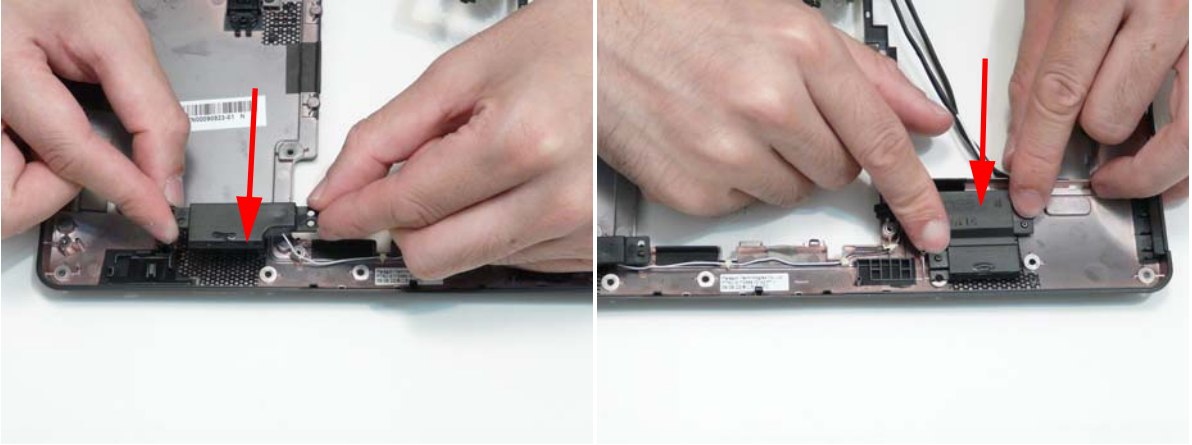

3. Replace the two (2) screws.

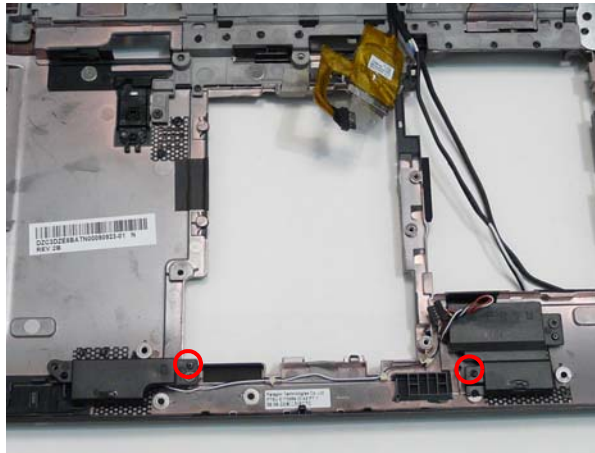

Step	Screw	Quantity	Screw Type.
Speaker	M2*3	2	

Replacing the Mainboard

1. Connect the CRT board cable.

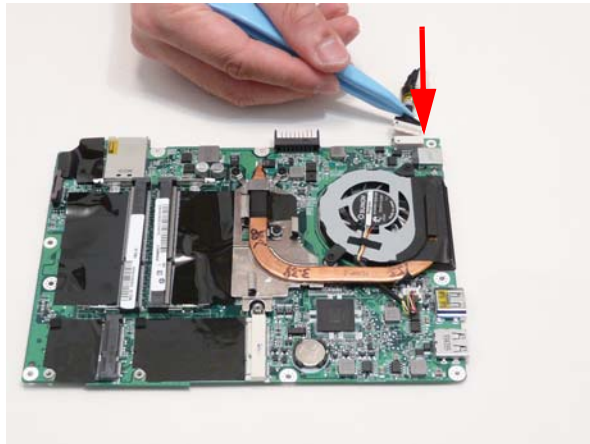

2. Replace the mainboard into the bottom cover inserting the external connector side first.



3. Replace the two (2) screws.



Step	Screw	Quantity	Screw Type.
Mainboard	M2*4	2	

4. Connect the speaker connector.

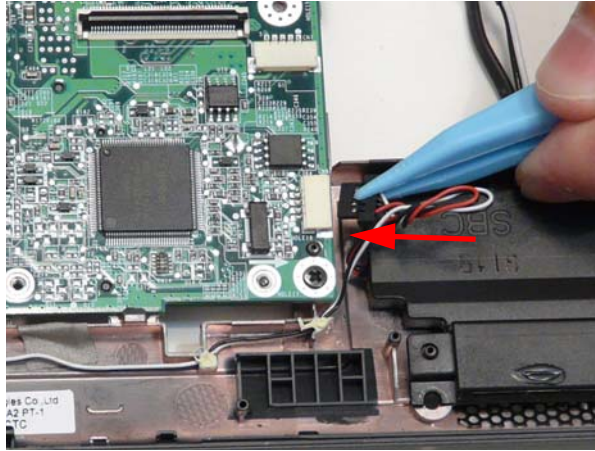

5. Connect the LCD connector.

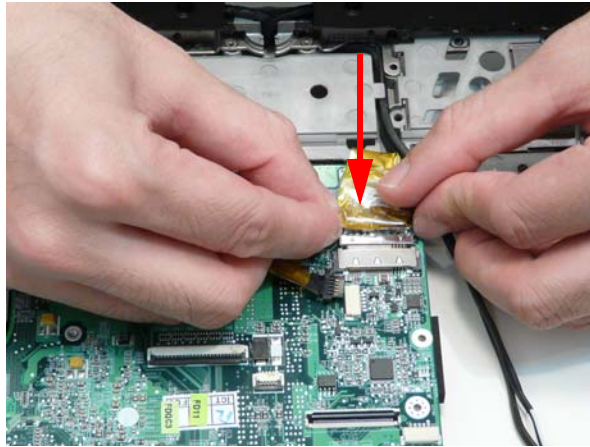

6. Adhere the clear protective LCD connector cover.

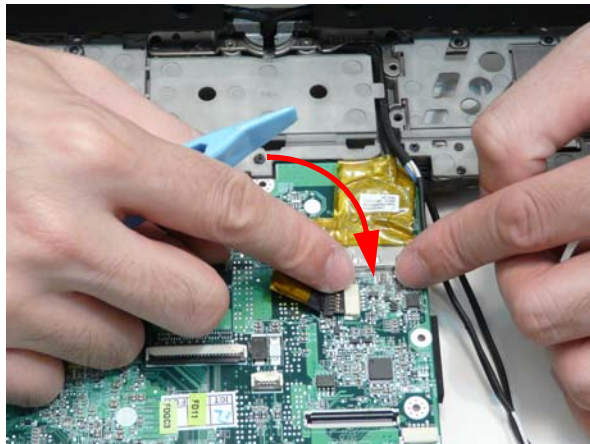

7. Connect the touchscreen cable.



Replacing the CRT Board.

1. Connect the CRT cable.

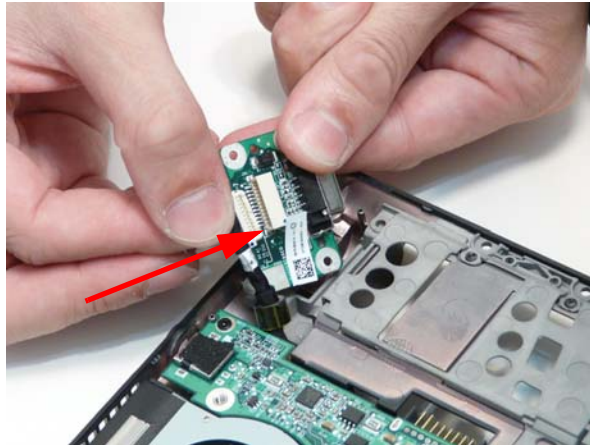

2. Turn the CRT board over.

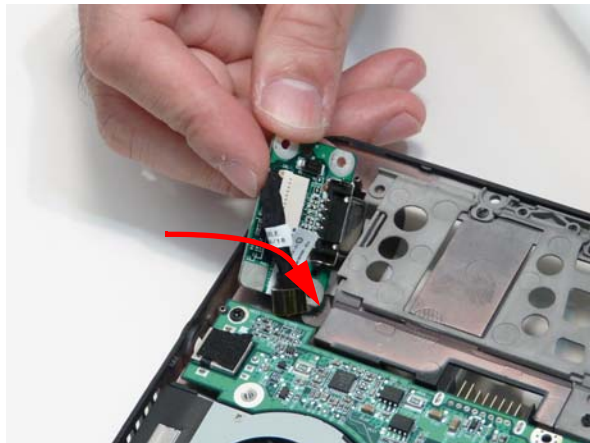

3. Place the CRT board into the cover.

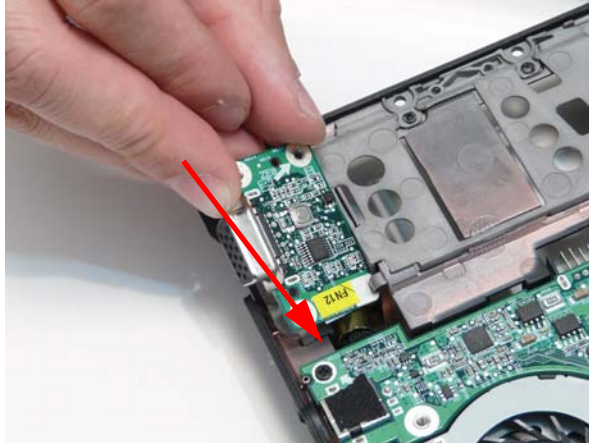

4. Replace the one (1) screw.



Step	Screw	Quantity	Screw Type.
CRT Board	M2*4	1	

Replacing the LED Board

1. Place the LED board onto the cover.

IMPORTANT: Take special care that the slider switch is properly aligned in the bottom case switch cover.

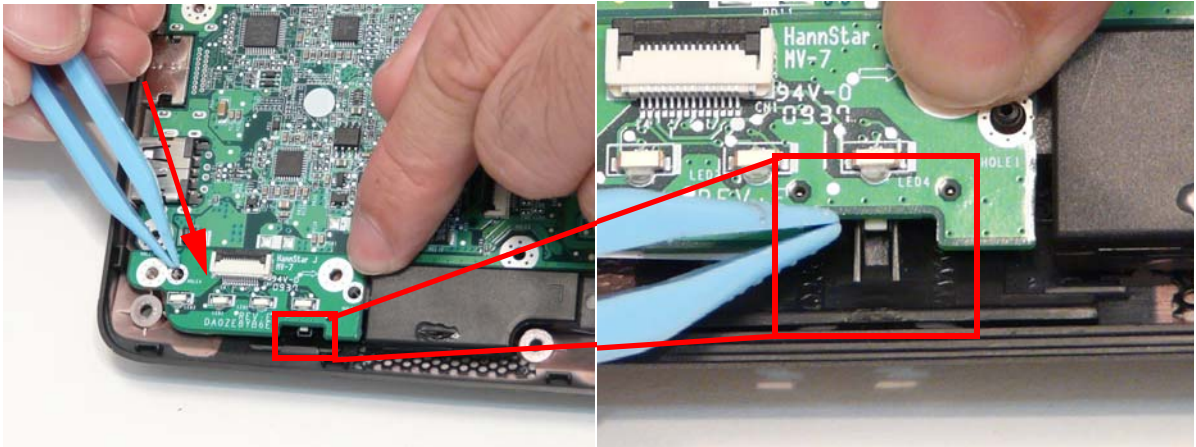

2. Replace the two (2) screws.

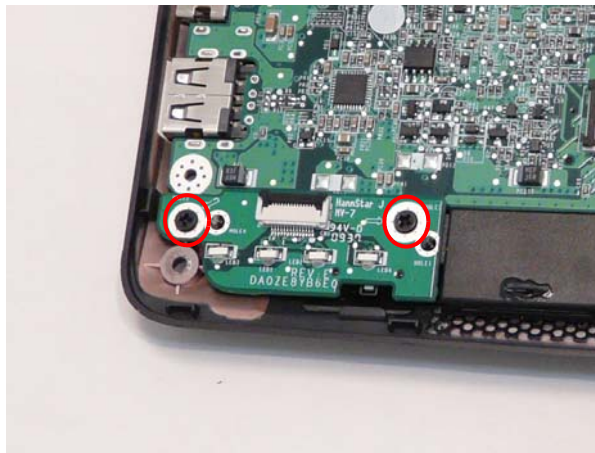

Step	Screw	Quantity	Screw Type.
LED Board	M2*4	2	

3. Replace the LED board cable in the main board connector.



4. Lock the mainboard connector.

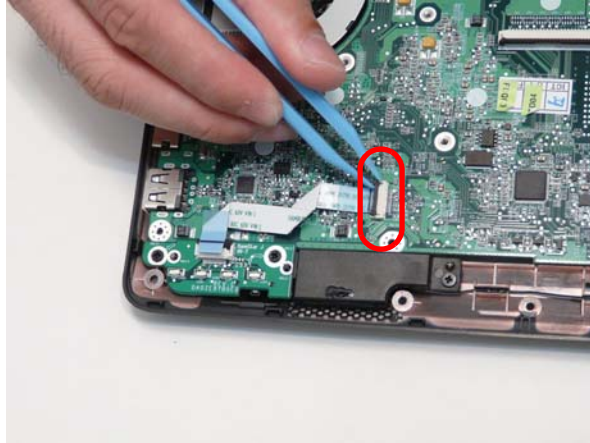

5. Replace the LED board cable in the LED board connector.

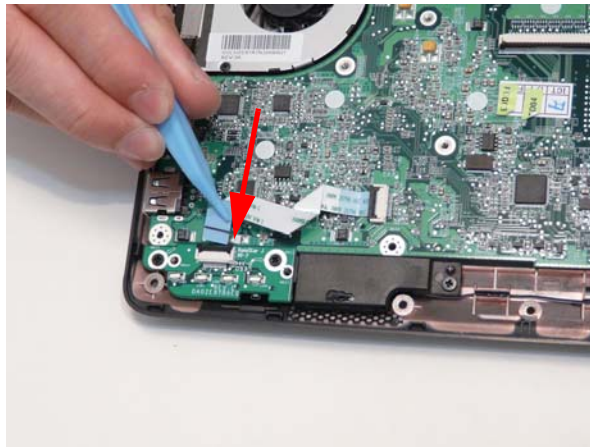

6. Lock the LED board connector.

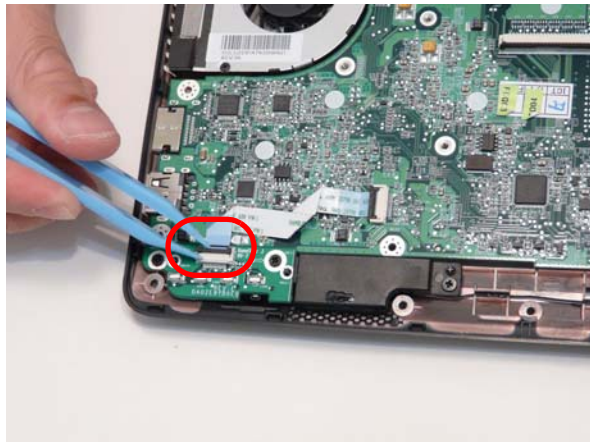

Replacing the Bluetooth Module

1. Adhere the Bluetooth module to the bottom cover.

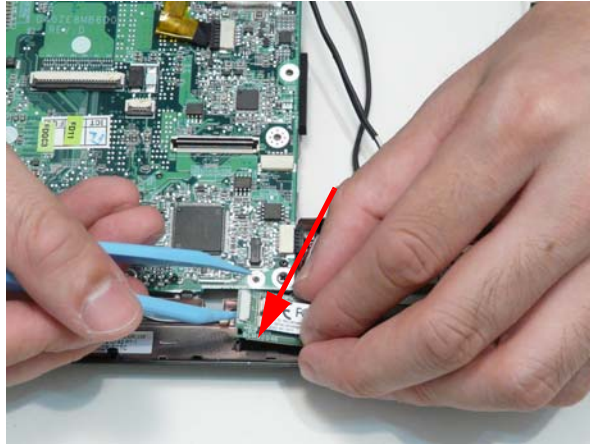

2. Connect the Bluetooth cable to the Bluetooth module.

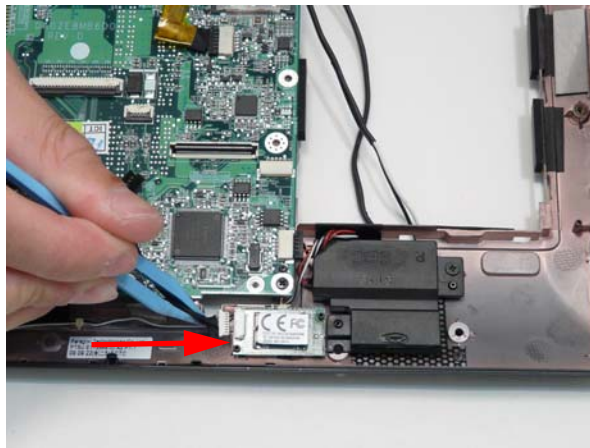

3. Connect the Bluetooth cable to the main board.

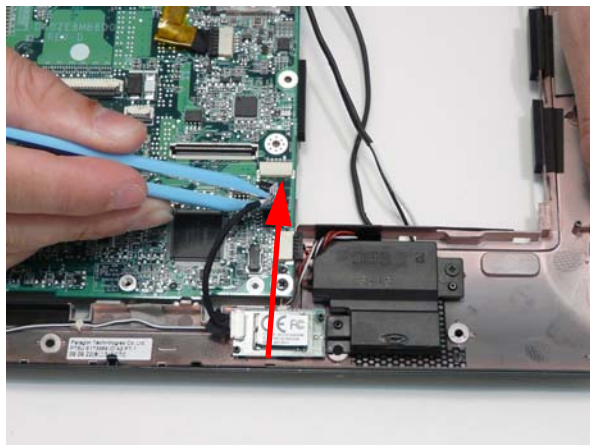

Replacing the I/O Board

1. Replace the I/O board inserting the external port side first.

NOTE: Ensure the power slide switch is properly aligned in the switch cover.

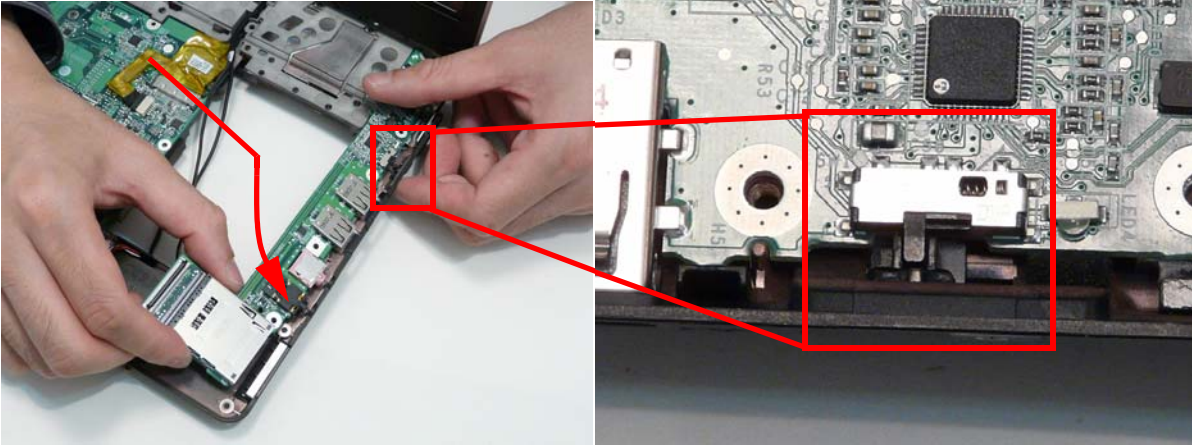

2. Turn the LCD module.



3. Replace the one (1) screw.



Step	Screw	Quantity	Screw Type.
I/O Board	M2*4	1	

4. Turn the LCD module.



5. Replace the I/O cable in the main board connector.

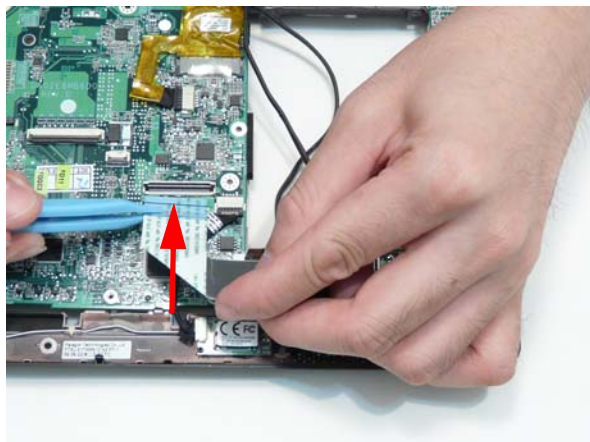

6. Lock the main board connector.

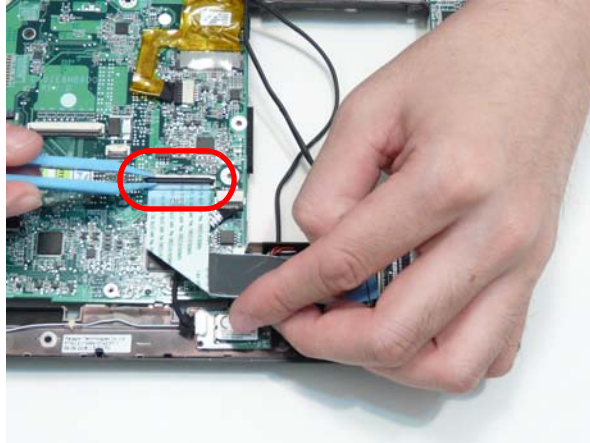

7. Replace the I/O cable in the IO board.

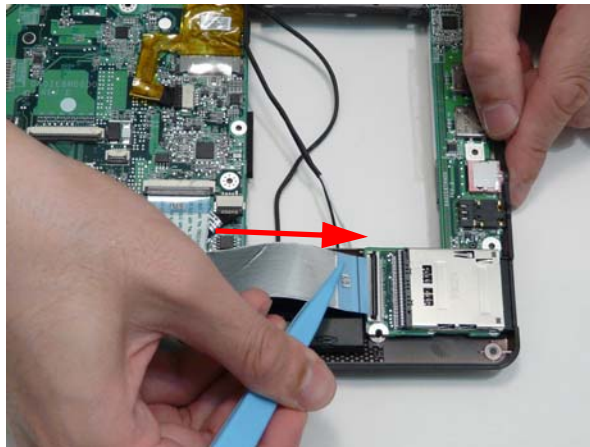

8. Lock the I/O board connector.

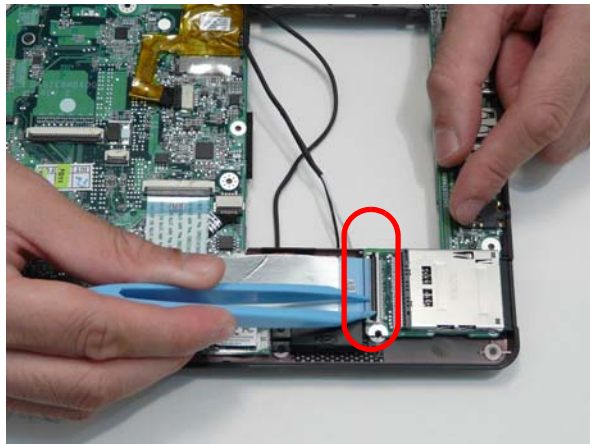

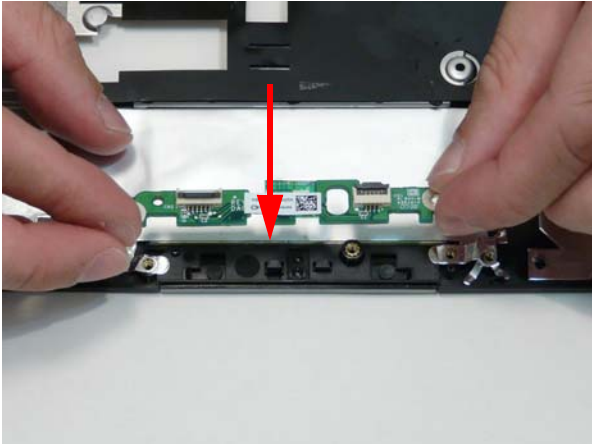

Replacing the Button Board

- 1. Replace the button board.

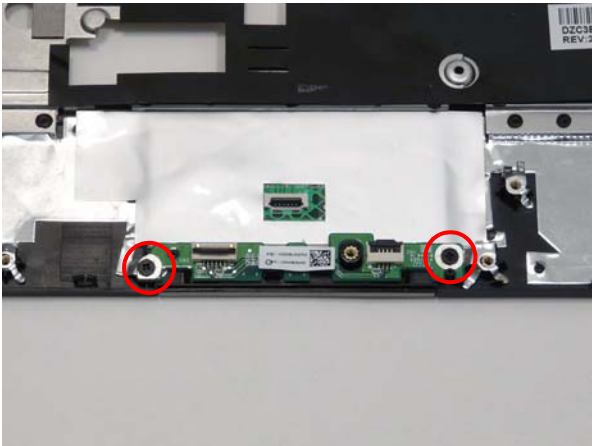

- 2. Replace the two (2) screws.



Step	Screw	Quantity	Screw Type.
Button Board	M2*3	2	

- 3. Replace the touchpad cable in the touchpad connector.

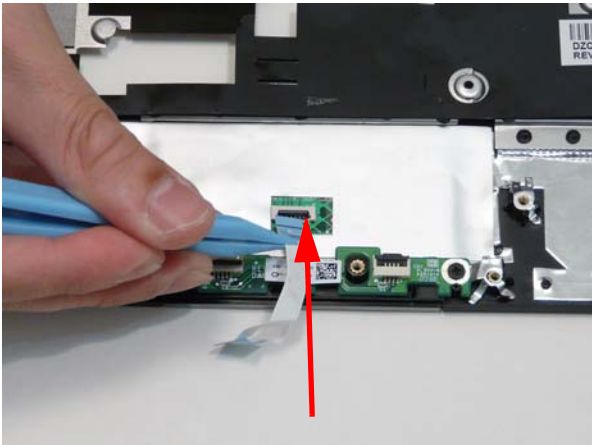

4. Lock the touchpad connector.

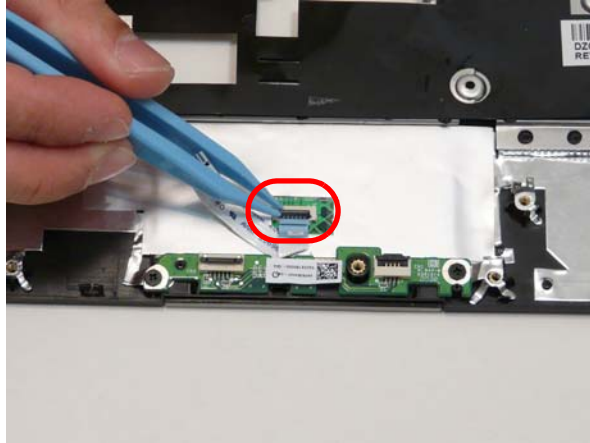

5. Adhere the touchpad cable to the upper cover.

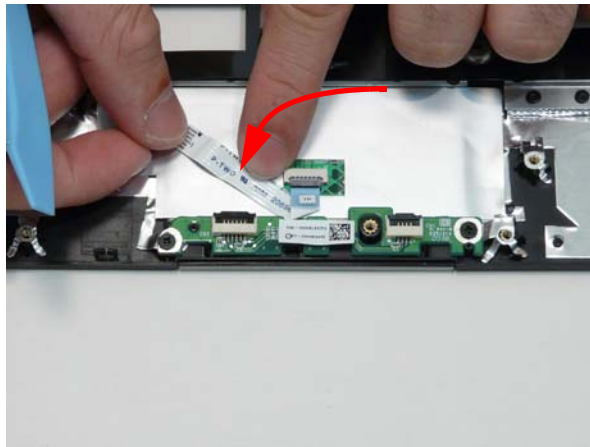

6. Replace the touchpad cable in the button board connector.

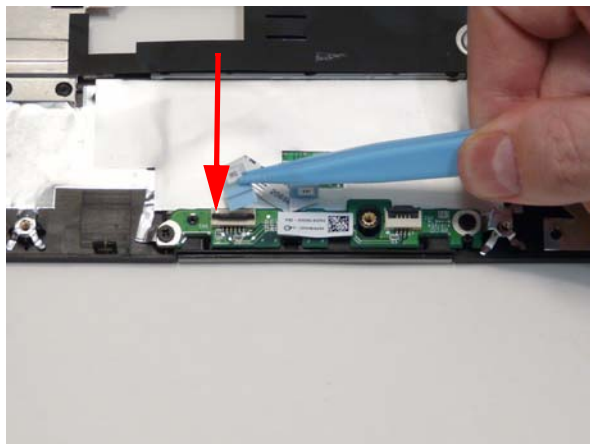

7. Lock the button board connector.

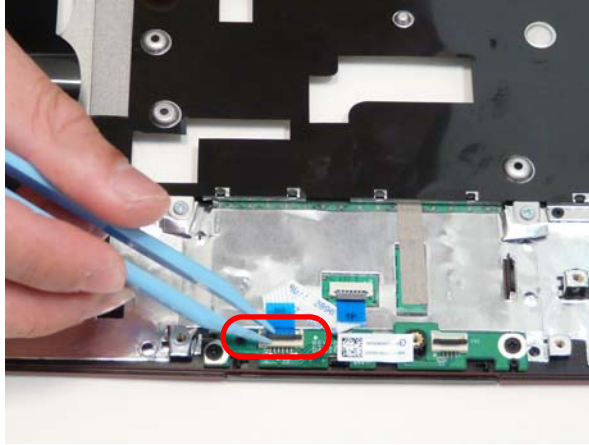

8. Replace the button board cable.

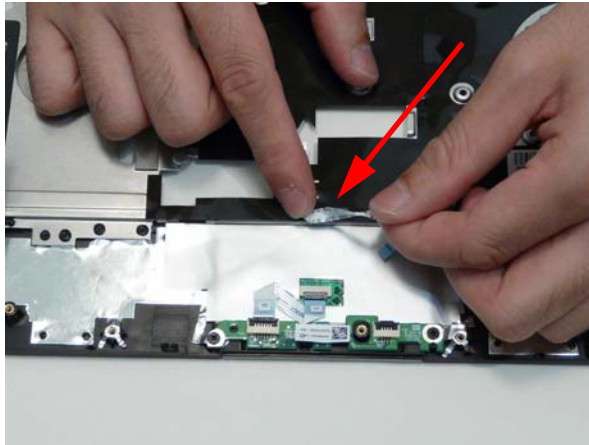

9. Adhere the button board cable to the upper cover.

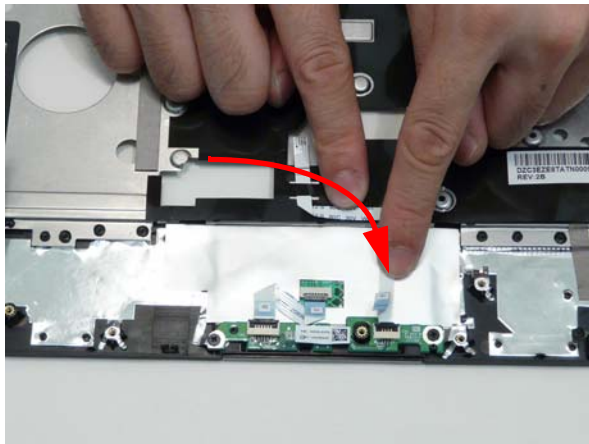

10. Connect the button board cable to the button board connector.

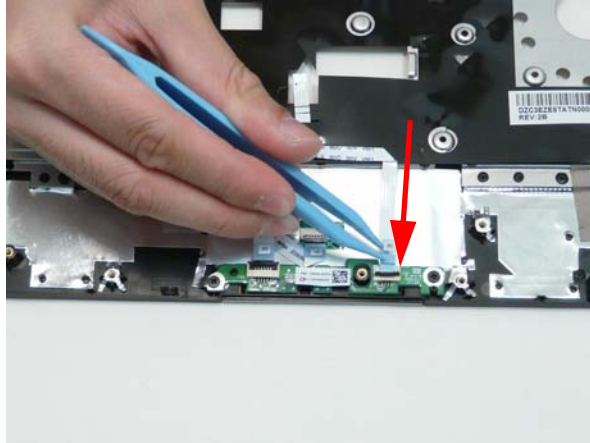

11. Lock the button board connector.

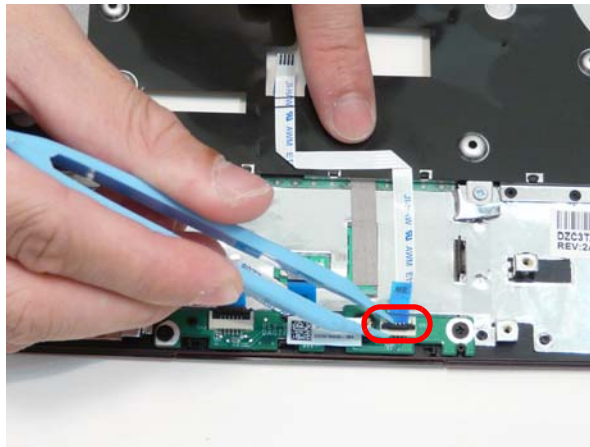

Replacing the Upper Cover

1. Replace the upper cover.

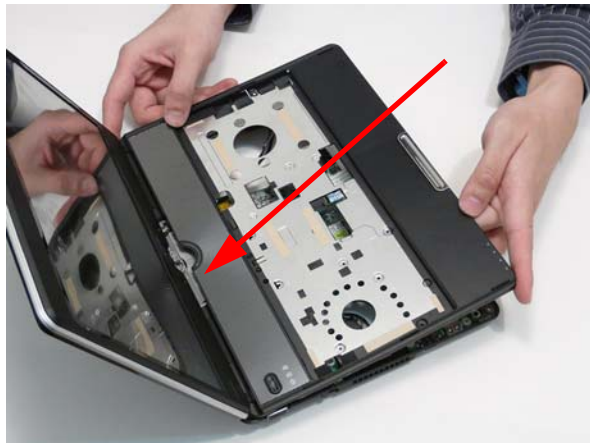

2. Press down on the left and right sides of the upper cover.



3. Press down on the bottom edge of the upper cover



4. Connect the button board cable.

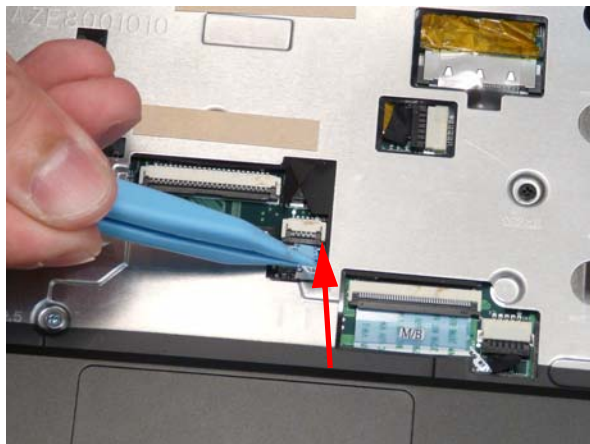

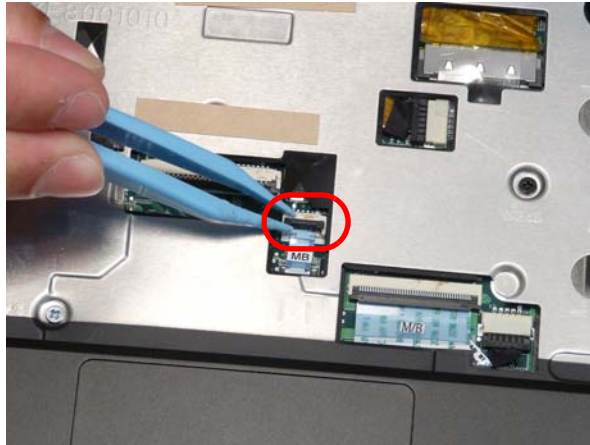

5. Lock the button board cable.



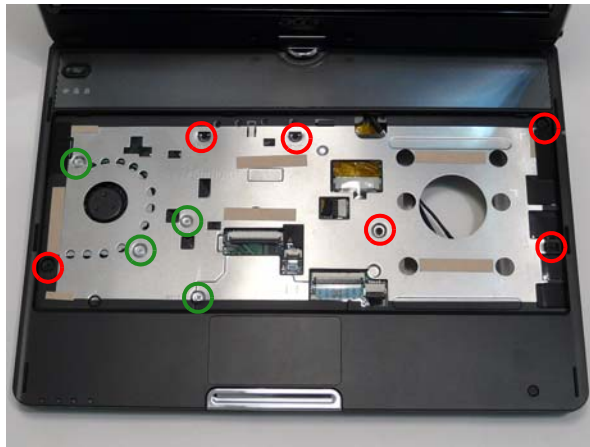

6. Replace the ten (10) screws in the upper cover.

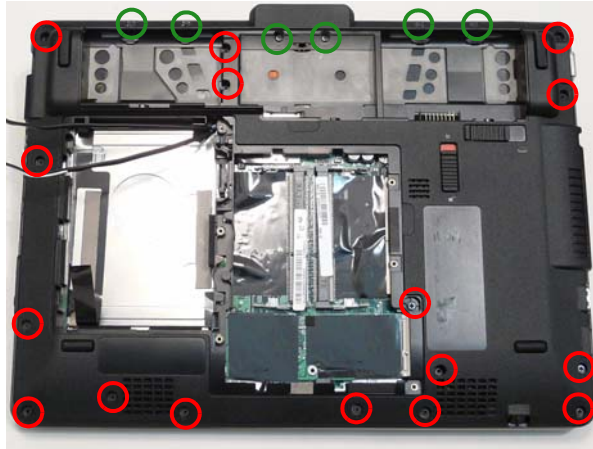

Step	Screw	Quantity	Screw Type.
Upper Cover	M2*5 (Red Call Out)	6	
	M2*2.5 (Green Call Out)	4	

7. Turn the computer over and replace the twenty-two (22) screws in the lower cover.



Step	Screw	Quantity	Screw Type.
Lower Cover	M2*5 (Red Call Out)	16	
	M2*4 (Green Call Out)	6	

Replacing the Hinge Covers

1. Replace the hinge bezel.



2. Replace the hinge cap.



3. Replace the three (3) screws.



Step	Screw	Quantity	Screw Type.
Hinge Covers	M2*3	3	

Replacing the Keyboard

1. Replace the keyboard FCP.

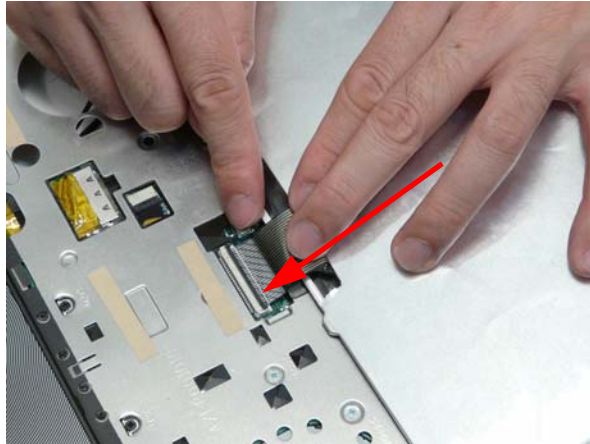

2. Lock the keyboard FCP.

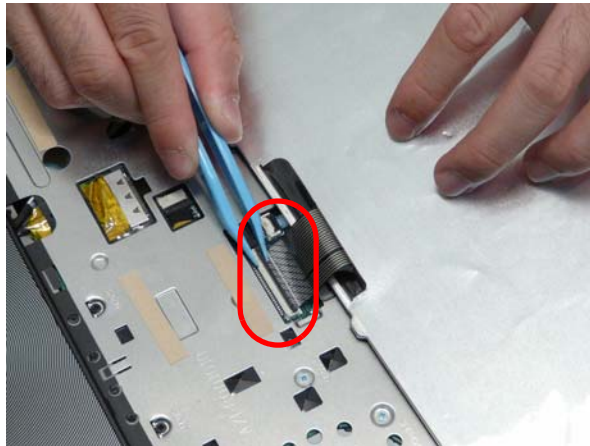

3. Flip the keyboard over and insert the front edge of the keyboard.



-
4. Press down the keyboard top edge.



Replacing the 3G Module

1. Replace the 3G module.



2. Replace the one (1) screw.



Step	Screw	Quantity	Screw Type.
3G Module	M2*3	1	

3. Connect the cables (Blue cable connects to Aux).



Replacing the WLAN Module

1. Replace the WLAN card.



2. Replace the one (1) screw.



Step	Screw	Quantity	Screw Type.
WLAN	M2*3	1	

3. Connect the cables (Black cable connects to Main).



Replacing the DIMM

1. Replace the DIMM module.

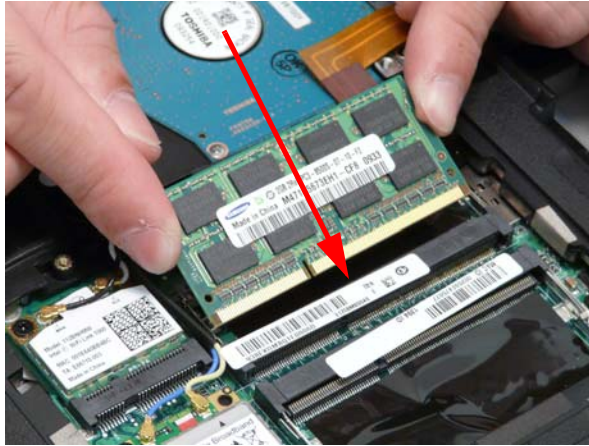

2. Press down the DIMM module to lock into place.

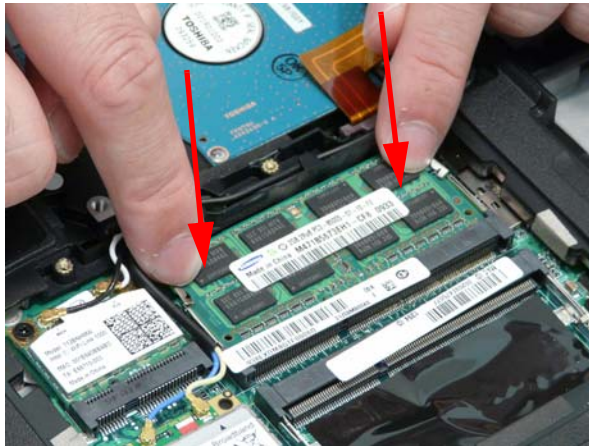

Replacing the Hard Disk Drive

1. Replace the HDD FCP.

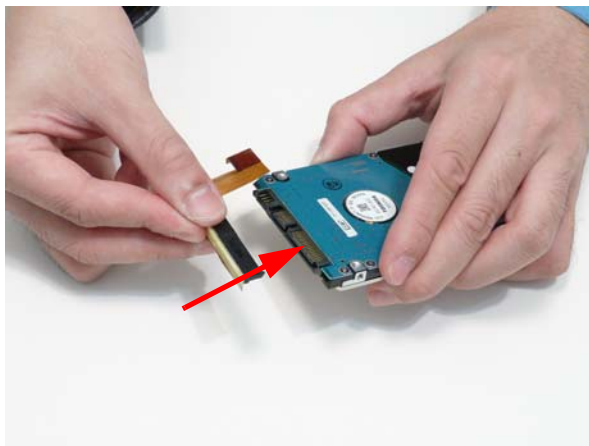

-
2. Replace the HDD in the bay.

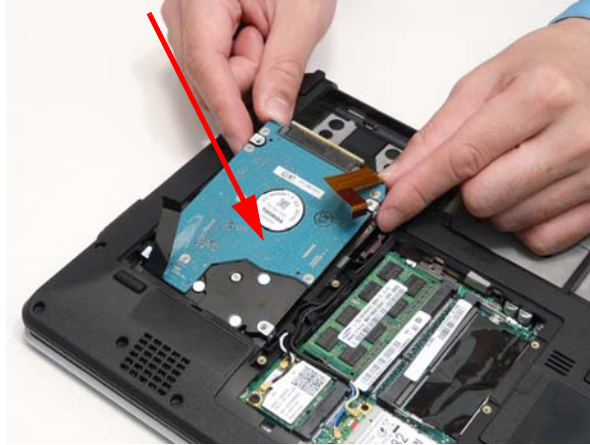

3. Adhere the black tape.



4. Replace the HDD FCP.

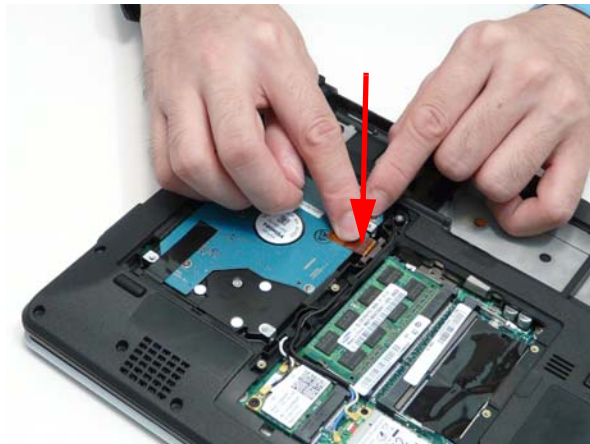

-
5. Lock the HDD FCP.

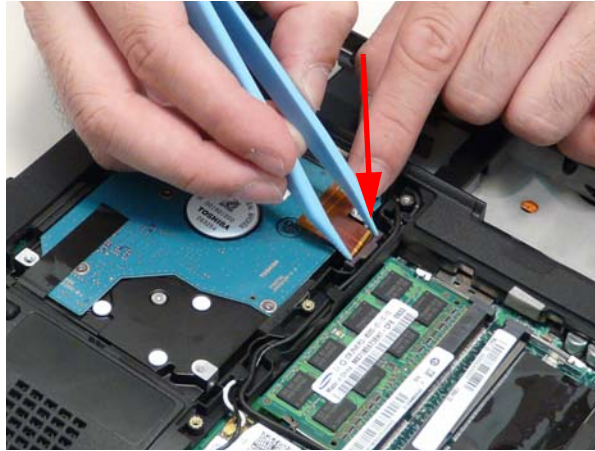

Replacing the Module Cover

1. Insert the side of the module cover into the slots.



2. Replace the module, pressing firmly around the edges.

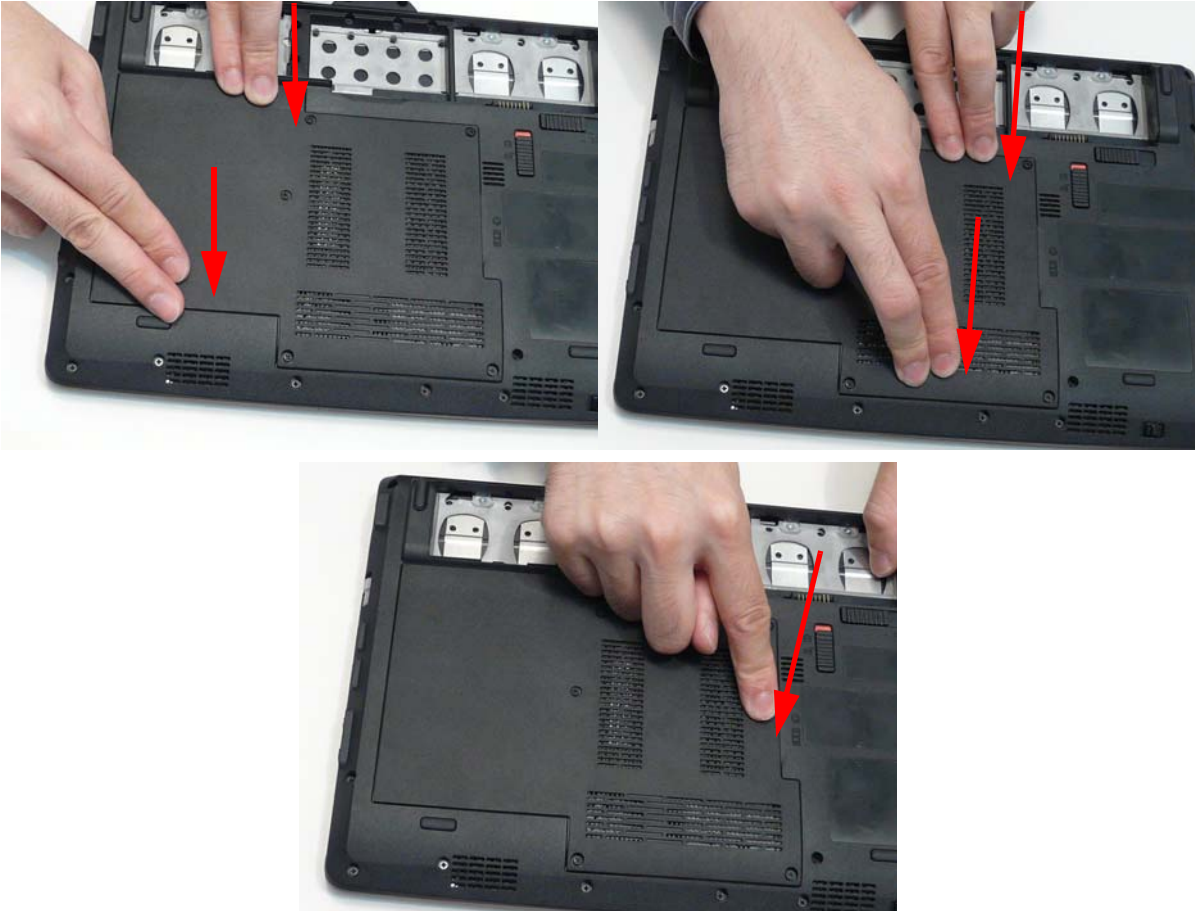

3. Tighten the six (6) captive screws.



Replacing the SIM Card

1. Insert the SIM card into the slot.



Replacing the Battery

1. Insert the battery outer edge into the slots.



2. Push the battery down into place.



-
3. Lock the battery.



Replacing the Dummy Card

1. Insert the dummy card into the slot.



Troubleshooting

Common Problems

Use the following procedure as a guide for computer problems.

NOTE: The diagnostic tests are intended to test only Acer products. Non-Acer products, prototype cards, or modified options can give false errors and invalid system responses.

1. Obtain the failing symptoms in as much detail as possible.
2. Verify the symptoms by attempting to re-create the failure by running the diagnostic test or by repeating the same operation.
3. Use the following table with the verified symptom to determine which page to go to.

Symptoms (Verified)	Go To
Power On Issue	Page 144
No Display Issue	Page 145
LCD Failure	Page 147
Internal Keyboard Failure	Page 148
TouchPad Failure	Page 149
Internal Speaker Failure	Page 150
Internal Microphone Failure	Page 151
USB Failure	Page 153
Other Function Failure	Page 153

4. If the Issue is still not resolved, see "Online Support Information" on page 165.

Power On Issue

If the system doesn't power on, perform the following actions one at a time to correct the problem. Do not replace non-defective FRUs:

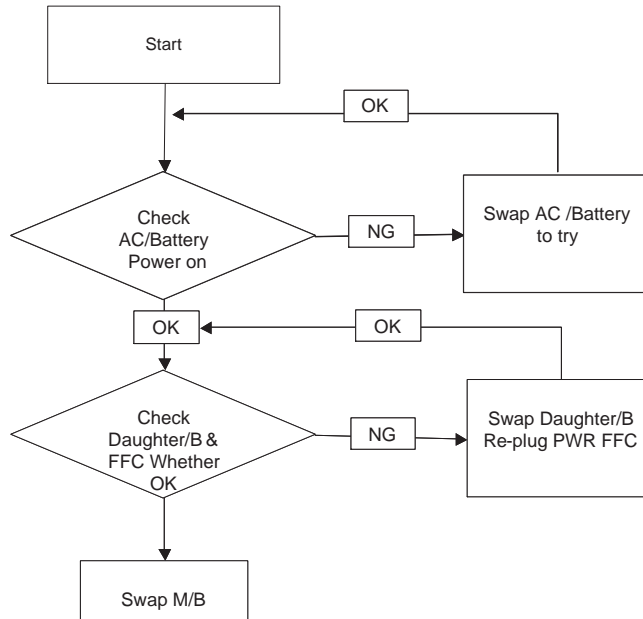

Computer Shuts down Intermittently

If the system powers off at intervals, perform the following actions one at a time to correct the problem.

1. Check the power cable is properly connected to the computer and the electrical outlet.
2. Remove any extension cables between the computer and the outlet.
3. Remove any surge protectors between the computer and the electrical outlet. Plug the computer directly into a known good electrical outlet.
4. Remove all external and non-essential hardware connected to the computer that are not necessary to boot the computer to the failure point.
5. Remove any recently installed software.
6. If the Issue is still not resolved, see "Online Support Information" on page 165.

No Display Issue

If the **Display** doesn't work, perform the following actions one at a time to correct the problem. Do not replace non-defective FRUs:

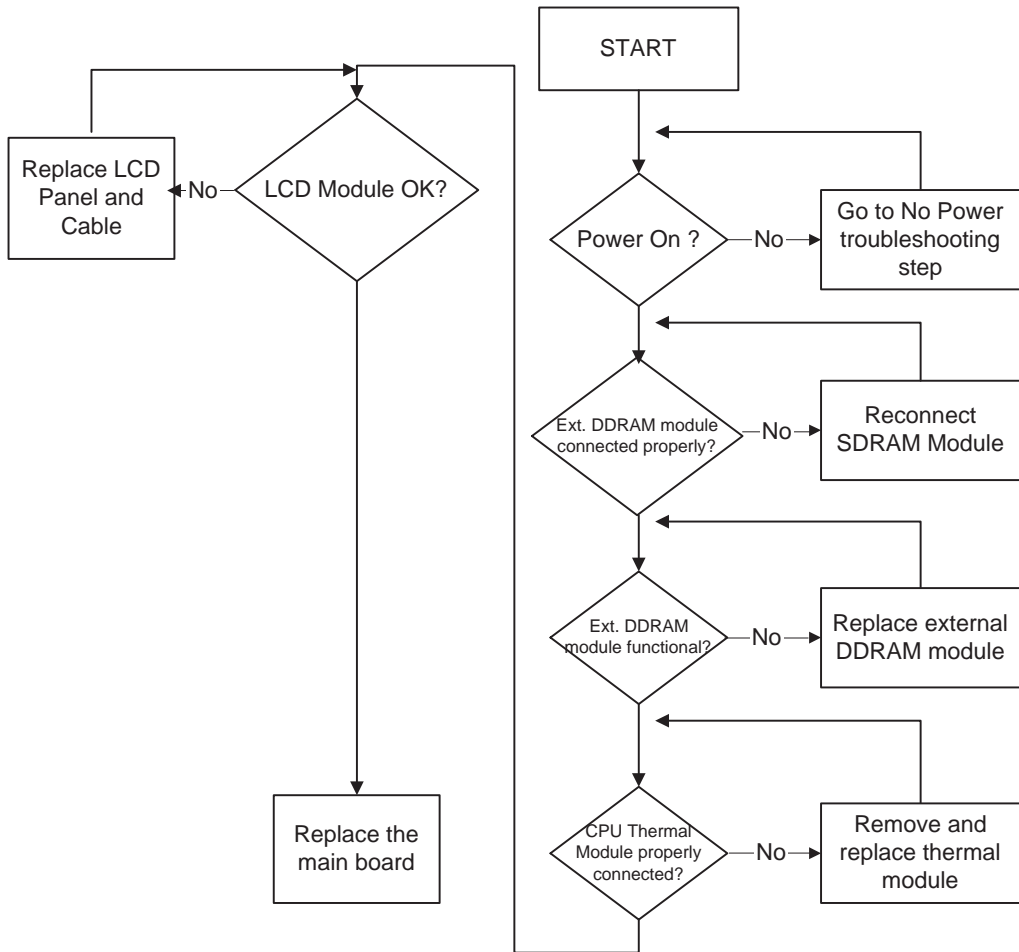

No POST or Video

If the POST or video doesn't display, perform the following actions one at a time to correct the problem.

1. Make sure that the internal display is selected. On this notebook model, switching between the internal display and the external display is done by pressing **Fn+F5**. Reference Product pages for specific model procedures.
2. Make sure the computer has power by checking at least one of the following occurs:
 - Fans start up
 - Status LEDs light up

If there is no power, see “Power On Issue” on page 144.

3. Drain any stored power by removing the power cable and battery and holding down the power button for 10 seconds. Reconnect the power and reboot the computer.
4. Connect an external monitor to the computer and switch between the internal display and the external display is by pressing **Fn+F5** (on this model).

If the POST or video appears on the external display, see “LCD Failure” on page 147.

5. Disconnect power and all external devices including port replicators or docking stations. Remove any memory cards and CD/DVD discs. Restart the computer.

If the computer boots correctly, add the devices one by one until the failure point is discovered.

6. Reseat the memory modules.
7. Remove the drives (see “Disassembly Process” on page 34).
8. If the Issue is still not resolved, see “Online Support Information” on page 165.

Abnormal Video Display

If video displays abnormally, perform the following actions one at a time to correct the problem.

1. Reboot the computer.
2. If permanent vertical/horizontal lines or dark spots display in the same location, the LCD is faulty and should be replaced. See “Disassembly Process” on page 34.
3. If extensive pixel damage is present (different colored spots in the same locations on the screen), the LCD is faulty and should be replaced. See “Disassembly Process” on page 34.
4. Adjust the brightness to its highest level. See the User Manual for instructions on adjusting settings.
NOTE: Ensure that the computer is not running on battery alone as this may reduce display brightness.

If the display is too dim at the highest brightness setting, the LCD is faulty and should be replaced. See “Disassembly Process” on page 34.

5. Check the display resolution is correctly configured:
 - a. Minimize or close all Windows.
 - b. If display size is only abnormal in an application, check the view settings and control/mouse wheel zoom feature in the application.
 - c. If desktop display resolution is not normal, right-click on the desktop and select **Personalize**→ **Display Settings**.
 - d. Click and drag the Resolution slider to the desired resolution.
 - e. Click **Apply** and check the display. Readjust if necessary.
6. Roll back the video driver to the previous version if updated.
7. Remove and reinstall the video driver.
8. Check the Device Manager to determine that:
 - The device is properly installed. There are no red Xs or yellow exclamation marks.
 - There are no device conflicts.
 - No hardware is listed under Other Devices.
9. If the Issue is still not resolved, see “Online Support Information” on page 165.
10. Run the Windows Memory Diagnostic from the operating system DVD and follow the onscreen prompts.
11. If the Issue is still not resolved, see “Online Support Information” on page 165.

Random Loss of BIOS Settings

If the computer is experiencing intermittent loss of BIOS information, perform the following actions one at a time to correct the problem.

1. If the computer is more than one year old, replace the CMOS battery.
2. Run a complete virus scan using up-to-date software to ensure the computer is virus free.
3. If the computer is experiencing HDD or ODD BIOS information loss, disconnect and reconnect the power and data cables between devices.

If the BIOS settings are still lost, replace the cables.

4. If HDD information is missing from the BIOS, the drive may be defective and should be replaced.
5. Replace the Motherboard.

6. If the Issue is still not resolved, see "Online Support Information" on page 165.

LCD Failure

If the **LCD** fails, perform the following actions one at a time to correct the problem. Do not replace non-defective FRUs:

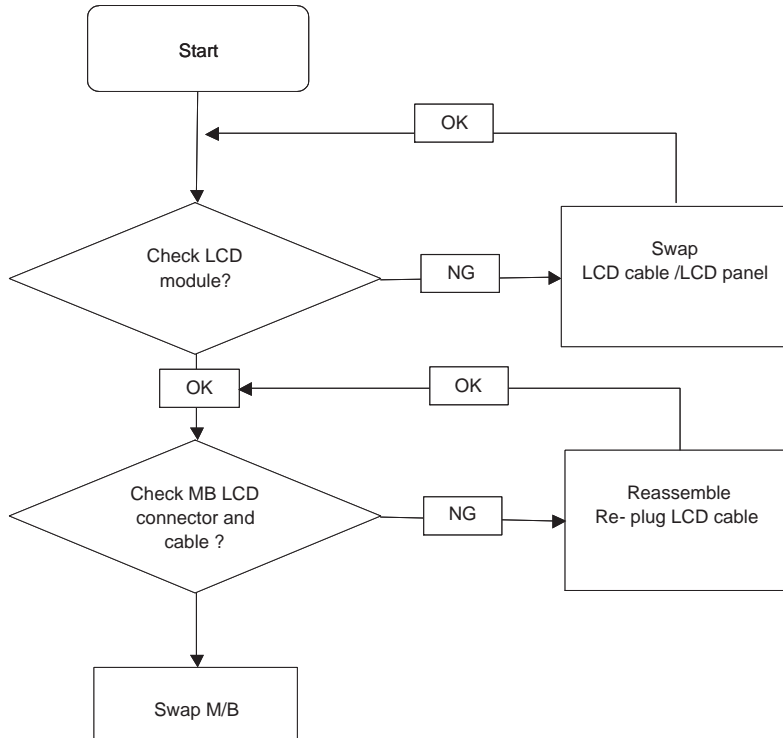

Built-In Keyboard Failure

If the built-in **Keyboard** fails, perform the following actions one at a time to correct the problem. Do not replace non-defective FRUs:

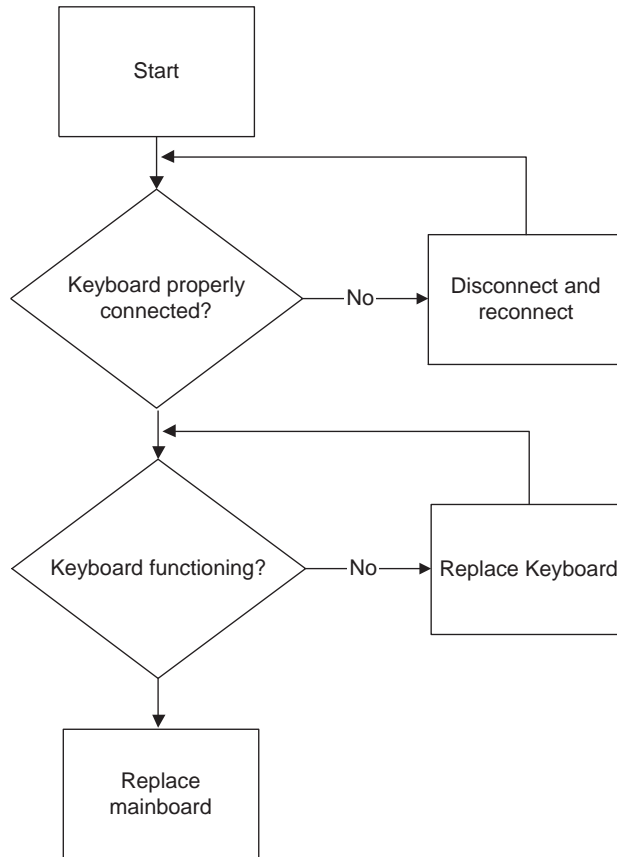

TouchPad Failure

If the **TouchPad** doesn't work, perform the following actions one at a time to correct the problem. Do not replace non-defective FRUs:

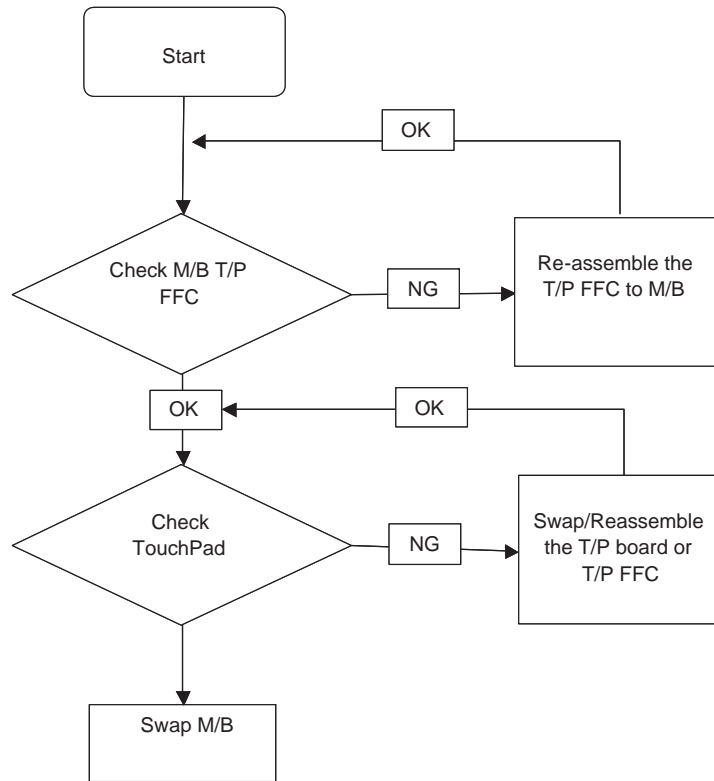

Internal Speaker Failure

If the internal **Speakers** fail, perform the following actions one at a time to correct the problem. Do not replace non-defective FRUs:

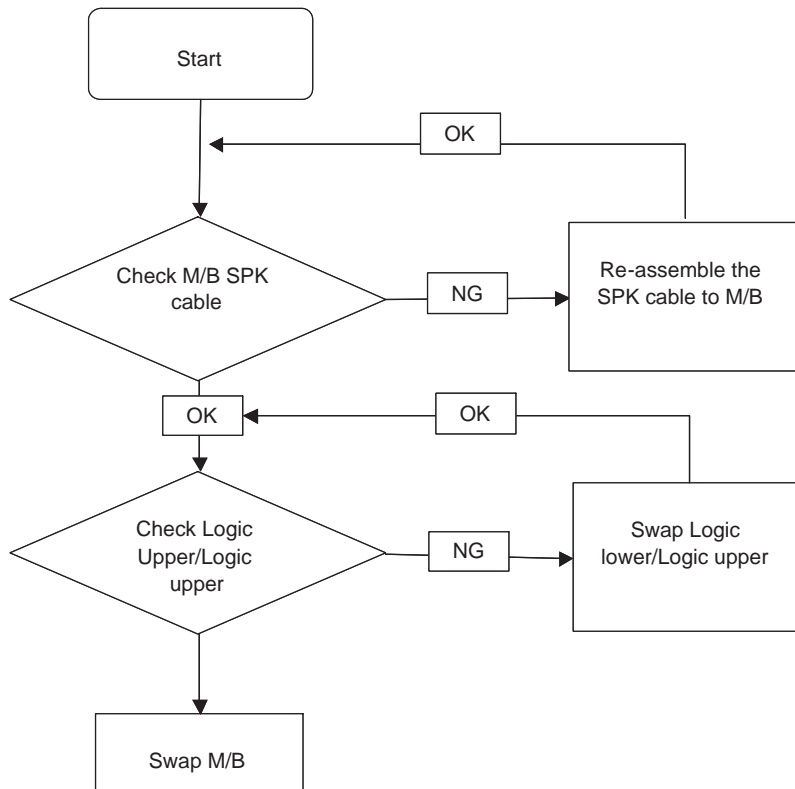

Sound Problems

If sound problems are experienced, perform the following actions one at a time to correct the problem.

1. Reboot the computer.
2. Navigate to **Start** → **Control Panel** → **System and Maintenance** → **System** → **Device Manager**. Check the Device Manager to determine that:
 - The device is properly installed.
 - There are no red Xs or yellow exclamation marks.
 - There are no device conflicts.
 - No hardware is listed under Other Devices.
3. Roll back the audio driver to the previous version, if updated recently.
4. Remove and reinstall the audio driver.
5. Ensure that all volume controls are set mid range:
 - a. Click the volume icon on the taskbar and drag the slider to 50. Ensure that the volume is not muted.
 - b. Click Mixer to verify that other audio applications are set to 50 and not muted.
6. Navigate to **Start** → **Control Panel** → **Hardware and Sound** → **Sound**. Ensure that Speakers are selected as the default audio device (green check mark).

NOTE: If Speakers does not show, right-click on the **Playback** tab and select **Show Disabled Devices** (clear by default).
7. Select Speakers and click **Configure** to start **Speaker Setup**. Follow the onscreen prompts to configure the speakers.

8. Remove and recently installed hardware or software.
9. Restore system and file settings from a known good date using **System Restore**.
If the issue is not fixed, repeat the preceding steps and select an earlier time and date.
10. Reinstall the Operating System.
11. If the Issue is still not resolved, see “Online Support Information” on page 165.

Internal Microphone Failure

If the internal **Microphone** fails, perform the following actions one at a time to correct the problem. Do not replace non-defective FRUs:

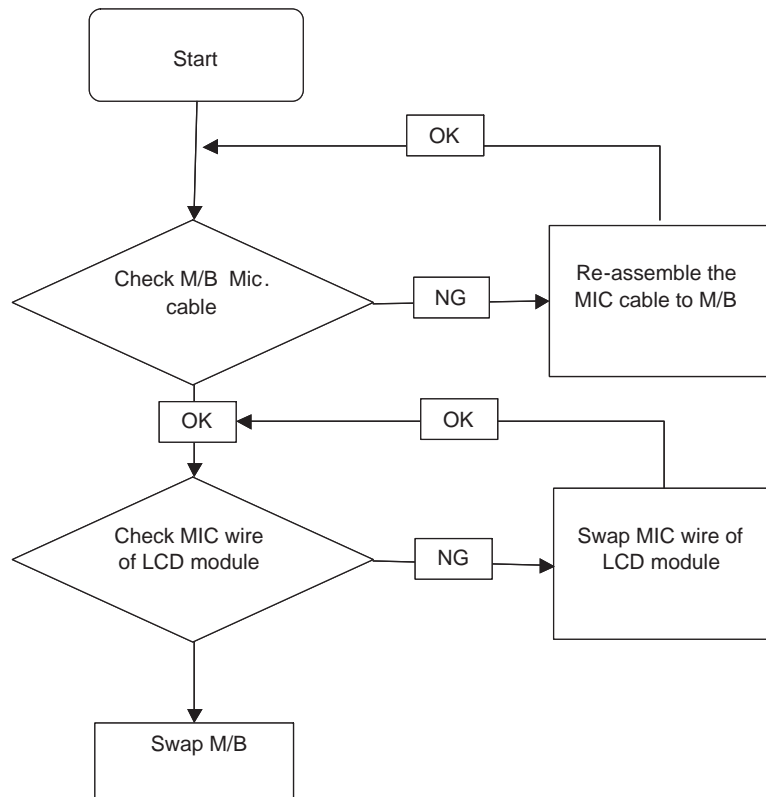

Microphone Problems

If internal or external **Microphones** do not operate correctly, perform the following actions one at a time to correct the problem.

1. Check that the microphone is enabled. Navigate to **Start** → **Control Panel** → **Hardware and Sound** → **Sound** and select the **Recording** tab.
2. Right-click on the **Recording** tab and select **Show Disabled Devices** (clear by default).
3. The microphone appears on the **Recording** tab.
4. Right-click on the microphone and select **Enable**.
5. Select the microphone then click **Properties**. Select the **Levels** tab.
6. Increase the volume to the maximum setting and click **OK**.
7. Test the microphone hardware:
 - a. Select the microphone and click **Configure**.
 - b. Select **Set up microphone**.

-
- c. Select the microphone type from the list and click **Next**.
 - d. Follow the onscreen prompts to complete the test.
8. If the Issue is still not resolved, see “Online Support Information” on page 165.

HDD Not Operating Correctly

If the **HDD** does not operate correctly, perform the following actions one at a time to correct the problem.

1. Disconnect all external devices.
2. Run a complete virus scan using up-to-date software to ensure the computer is virus free.
3. Run the Windows 7 Startup Repair Utility:
 - a. insert the Windows 7 Operating System DVD in the ODD and restart the computer.
 - b. When prompted, press any key to start to the operating system DVD.
 - c. The **Install Windows** screen displays. Click **Next**.
 - d. Select **Repair your computer**.
 - e. The **System Recovery Options** screen displays. Click **Next**.
 - f. Select the appropriate operating system, and click **Next**.

NOTE: Click **Load Drivers** if controller drives are required.

- g. Select **Startup Repair**.
- h. Startup Repair attempts to locate and resolve issues with the computer.
- i. When complete, click **Finish**.

If an issue is discovered, follow the onscreen information to resolve the problem.

4. Run the Windows Memory Diagnostic Tool. For more information see Windows Help and Support.
5. Restart the computer and press F2 to enter the BIOS Utility. Check the BIOS settings are correct and that CD/DVD drive is set as the first boot device on the Boot menu.
6. Ensure all cables and jumpers on the HDD and ODD are set correctly.
7. Remove any recently added hardware and associated software.
8. Run the Windows Disk Defragmenter. For more information see Windows Help and Support.
9. Run Windows Check Disk by entering **chkdsk /r** from a command prompt. For more information see Windows Help and Support.
10. Restore system and file settings from a known good date using **System Restore**.

If the issue is not fixed, repeat the preceding steps and select an earlier time and date.
11. Replace the HDD. See “Disassembly Process” on page 34.

USB Failure (Right up/down side)

If the rightside **USB** port fails, perform the following actions one at a time to correct the problem. Do not replace non-defective FRUs:

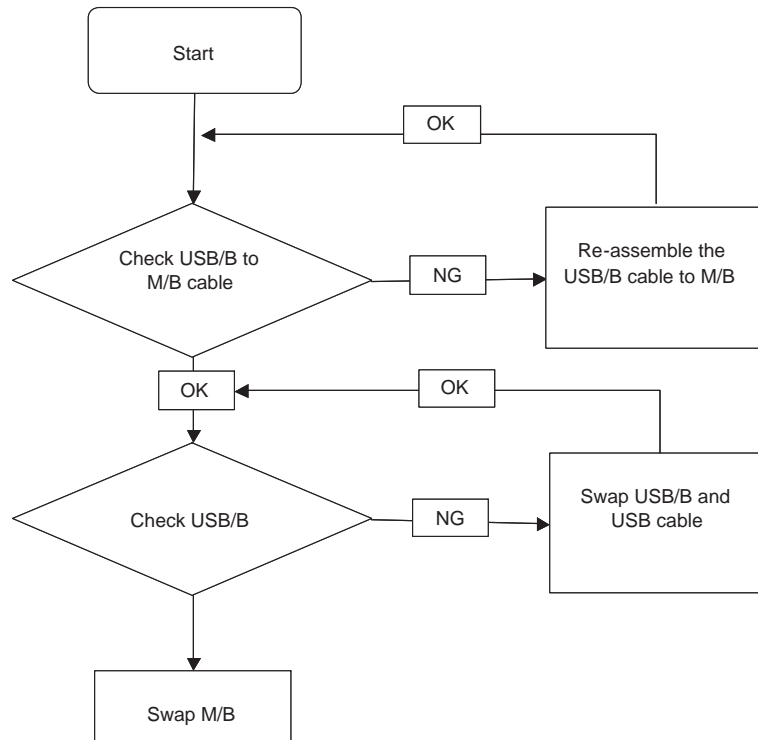

Other Failures

If the VGA board, LAN Port, external MIC or Speakers, PCI Express Card, 5-in-1 Card Reader or Volume Wheel fail, perform the following general steps to correct the problem. Do not replace non-defective FRUs:

1. Check whether the drive is OK.
2. Verify that the Test Fixture is ok.
3. Swap the main board and retest.

Intermittent Problems

Intermittent system hang problems can be caused by a variety of reasons that have nothing to do with a hardware defect, such as: cosmic radiation, electrostatic discharge, or software errors. FRU replacement should be considered only when a recurring problem exists.

When analyzing an intermittent problem, do the following:

1. Run the advanced diagnostic test for the system board in loop mode at least 10 times.
2. If no error is detected, do not replace any FRU.
3. If any error is detected, replace the FRU. Rerun the test to verify that there are no more errors.

Undetermined Problems

The diagnostic problems does not identify which adapter or device failed, which installed devices are incorrect, whether a short circuit is suspected, or whether the system is inoperative.

Follow these procedures to isolate the failing FRU (do not isolate non-defective FRU).

NOTE: Verify that all attached devices are supported by the computer.

NOTE: Verify that the power supply being used at the time of the failure is operating correctly. (See “Power On Issue” on page 144.):

1. Power-off the computer.
2. Visually check them for damage. If any problems are found, replace the FRU.
3. Remove or disconnect all of the following devices:
 - Non-Acer devices
 - Printer, mouse, and other external devices
 - Battery pack
 - Hard disk drive
 - DIMM
 - CD-ROM/Diskette drive Module
 - PC Cards
4. Power-on the computer.
5. Determine if the problem has changed.
6. If the problem does not recur, reconnect the removed devices one at a time until you find the failing FRU.
7. If the problem remains, replace the following FRU one at a time. Do not replace a non-defective FRU:
 - System board
 - LCD assembly

Post Codes

These tables describe the Post Codes and components of the POST process.

Sec:

NO_EVICTION_MODE_DEBUG EQU 1 (CommonPlatform\sec\la32\SecCore.inc)

0x C2	MTRR setup
0x C3	Enable cache
0x C4	Establish cache tags
0x C5	Enter NEM, Place the BSP in No Fill mode, set CR0.CD = 1, CR0.NW = 0.
0xCF	Cache Init Finished

Memory:

DEBUG_BIOS EQU 1 (Chipset\Alviso\MemoryInitAsm\IA32\IMEMORY.INC)

0x A0	First memory check point
0x 01	Enable MCHBAR
0x 02	Check for DRAM initialization interrupt and reset fail
0x 03	Verify all DIMMs are DDR or DDR2 and unbuffered
0x 04	Detect an improper warm reset and handle
0x 05	Detect if ECC SO-DIMMs are present in the system
0x 06	Verify all DIMMs are single or double sided and not asymmetric
0x 07	Verify all DIMMs are x8 or x16 width
0x 08	Find a common CAS latency between the DIMMS and the MCH
0x 09	Determine the memory frequency and CAS latency to program
0x 10	Determine the smallest common TRAS for all DIMMs
0x 11	Determine the smallest common TRP for all DIMMs
0x 12	Determine the smallest common TRCD for all DIMMs
0x 13	Determine the smallest refresh period for all DIMMs

0x 14	Verify burst length of 8 is supported by all DIMMs
0x 15	Determine the smallest tWR supported by all DIMMs
0x 16	Determine DIMM size parameters
0x 17	Program the correct system memory frequency
0x 18	Determine and set the mode of operation for the memory channels
0x 19	Program clock crossing registers
0x 20	Disable Fast Dispatch
0x 21	Program the DRAM Row Attributes and DRAM Row Boundary registers
0x 22	Program the DRAM Bank Architecture register
0x 23	Program the DRAM Timing & and DRAM Control registers
0x 24	Program ODT
0x 25	Perform steps required before memory init
0x 26	Program the receive enable reference timing control register Program the DLL Timing Control Registers, RCOMP settings
0x 27	Enable DRAM Channel I/O Buffers
0x 28	Enable all clocks on populated rows
0x 29	Perform JEDEC memory initialization for all memory rows
0x 30 0x 31	Perform steps required after memory init Program DRAM throttling and throttling event registers
0x 32	Setup DRAM control register for normal operation and enable
0x 33	Enable RCOMP
0x 34	Clear DRAM initialization bit in the SB
0x 35	Initialization Sequence Completed, program graphic clocks
0x AF	Disable access to the XMM registers

BDS & Specific action:

0x0 0	Report the legacy boot is happening
0x1 2	Wake up the APs
0x1 3	Initialize SMM Private Data and relocate BSP SMBASE
0x2 1 0x2 7	PC init begin at the stage1 Report every memory range do the hard ware ECC init
0x2 8	Report status code of every memory range
0x5 0	Get the root bridge handle
0x5 1	Notify pci bus driver starts to program the resource
0x5 8	Reset the host controller
0x5A	IdeBus begin initialization
0x7 0	Simple Text Output Protocol Functions(VGA class reset)
0x7 1	Report that VGA Class driver is being disabled
0x7 2	Report that VGA Class driver is being enabled
0x7 8	Terminal Console In reset and Console Out reset
0x7 9	Report that the remote terminal is being disabled
0x7A	Report that the remote terminal is being enabled
0x9 0	Keyboard reset
0x9 1	USB Keyboard disable
0x9 2	Keyboard detection
0x9 3	Report that the usb keyboard is being enabled
0x9 4	Clear the keyboard buffer
0x9 5	Init Keyboard
0x9 8	Mouse reset

0x99 0x9A	Mouse disable Detect PS2 mouse
0x9B	Report that the mouse is being enabled
0xB8	Peripheral removable media reset(ex:IsaFloppy, USB device)
0xB9	Peripheral removable media disable
0xBB	Peripheral removable media enable
0xE4	Report Status Code here for DXE_ENTRY_POINT once it is available
0xF8	Report that ExitBootServices() has been called
0xF9	Runtime driver set virtual address map

Each PEIM entry point used in 80_PORT

0x00	
0x01	PEI_EVENT_LOG
0x02	PEI_OEM_SERVICE
0x03	PEI_SIO_INIT
0x04	PEI_MONO_STATUS_CODE
0x05	PEI_CPU_IO_PCI_CFG
0x06	PEI_CPU_IO
0x07	PEI_PCI_CFG
0x08	PEI_CPU_PEIM
0x09	PEI_PLATFORM_STAGE1
0x0A	PEI_VARIABLE
0x0B 0x0C	PEI_SB_INIT PEI_CAPSULE
0x0D	PEI_PLATFORM_STAGE2
0x0E	PEI_SB_SMBUS_ARP_DISABLED
0x0F	PEI_HOST_TO_SYSTEM
0x10	PEI_MEMORY_INIT

0x11	PEI_S3_RESUME
0x12	PEI_CLOCK_GEN
0x13	PEI_OP_PRESENCE
0x14	PEI_TPM_TCG
0x15	PEI_FIND_FV
0x16	PEI_H2O_DEBUG_IO
0x17	PEI_H2O_DEBUG_COMM
0x18	PEI_SMM_CONTROL
0x19~0x1F	PEI_RESERVED
0x20~0x2E	PEI_OEM_DEFINED
0x2F	PEI_DXE_IPL

Each Driver entry point used in 80_PORT

0x30	RESERVED
0x31	DXE_CRC32_SECTION_EXTRACT
0x32	SCRIPT_SAVE
0x33	ACPI_S3_SAVE
0x34	SMART_TIMER
0x35	JPEG_DECODER
0x36	PCX_DECODER
0x37	HT_CPU / MP_CPU
0x38	LEGACY_METRONOME
0x39	FTWLITE
0x3A	RUN_RIME
0x3B	MONOTONIC_COUNTER
0x3C	WATCH_DOG_TIMER

0x3D	SECURITY_STUB
0x3E	DXE_CPU_IO
0x3F	CF9_RESET
0x40	PC_RTC
0x41	STATUS_CODE
0x42	VARIABLE
0x43	EMU_VARIABLE
0x44	DXE_CHIPSET_INIT
0x45	DXE_ALERT_FORMAT
0x46	PCI_HOST_BRIDGE
0x47	PCI_EXPRESS
0x48	DXE_SB_INIT
0x49	IDE_CONTROLLER
0x4A 0x4B	SATA_CONTROLLER SB_SM_BUS
0x4C	ISA_ACPI_DRIVER
0x4D	ISA_BUS
0x4E	ISA_SERIAL
0x4F	IDE_BUS
0x50	PCI_BUS
0x51	BOOT_PRIORITY
0x52	FVB_SERVICE
0x53	ACPI_PLATFORM
0x54	PCI_HOT_PLUG
0x55	DXE_PLATFORM

0x56	PLATFORM_IDE
0x57	SMBIOS
0x58	MEMORY_SUB_CLASS
0x59	MISC_SUB_CLASS
0x5A	CON_PLATFORM
0x5B	SAVE_MEMORY_CONFIG
0x5C	ACPI_SUPPORT
0x5D	CON_SPLITTER_UGA_VGA / CON_SPLITTER
0x5E	VGA_CLASS
0x5F	DATA_HUB
0x60	DISK_IO
0x61 0x62	MEMORY_TEST CRISIS_RECOVERY
0x63	LEGACY_8259
0x64	LEGACY_REGION
0x65	LEGACY_INTERRUPT
0x66	BIOS_KEYBOARD
0x67	BIOS_VEDIO
0x68	MONITER_KEY
0x69	LEGACY_BIOS
0x6A	LEGACY_BIOS_PLATFORM
0x6B	PCI_PLATFORM
0x6C	ISA_FLOOPY
0x6D	PS2_MOUSE
0x6E	USB_BOT
0x6F	USB_CBIO

0x70	USB_CBI1
0x71	USB_KB
0x72	USB_MASS_STORAGE
0x73	BUS_PCI_UHCI
0x74	USB_MOUSE
0x75	USB_BUS
0x76	SETUP_UTILITY
0x77	FW_BLOCK_SERVICE
0x78 0x79	USB_LEGACY_PLATFORM GRAPHICS_CONSOLE
0x7A	TERMINAL
0x7B	DATA_HUB_STD_ERR
0x7C	FAT
0x7D	PARTITION
0x7E	ENGLISH
0x7F	FRENCH
0x80	HII_DATABASE
0x81	SETUP_BROWSER
0x82	OEM_SETUP_BROWSER
0x83	OEM_BADGING_SUPPORT
0x84	LEGACY_MOUSE
0x85	BIOS_SNP16
0x86	BUS_PCI_UNDI
0x87	SETUP_MOUSE
0x88	OEM_SETTING

0x89	MONITOR_KEY
0x8A	PLATFORM_BDS
0x8B	FAULT_TOLERANT_WRITE
0x8C	UPDATE_DISPATCHER
0x8D	CHINESE
0x8E	TPM_S3_Resume
0x8F 0x90	USB_EHCI SNP_32_64
0x91	PXE_BC
0x92	PXE_DHCP4
0x93	EBC
0x94~0x9F	RESERVED
0xA0	DXE_H2O_DEBUG_IO
0xA1	DXE_H2O_DEBUG_IO
0xA2	DXE_TPM_TCG
0xA3	DXE_TPM_PHYSICAL_PRESENCE
0xA4	DXE_OEM_SERVICE
0xA5	DXE_EVENT_LOG
0xA6 0xA7	DXE_SECURITY_HDD_PASSWORD_SERVICE DXE_LAN_ASF_INIT
0xA8	DXE_BUS_PCI_SERIAL
0xA9	DXE_LAN_IDER_CONTROLLER
0xAA	DXE_LAN_AMT
0xAB	DXE_SECURITY_SYSTEM_PASSWORD_SERVICE
0xAC	DXE_SECURITY_PASSWORD_CONSOLE
0xAD	DXE_DATA_HUB_RECORD_POLICY
0xAE	DXE_TPM_DRIVER
0xAF	RESERVED
0xB0 0xB1	JAPANESE DXE_UNICODE_COLLATION

Each SmmDriver entry point used in 80_PORT

0xC0	SMM_ACCESS
-------------	------------

0xC1	SMM_CONTROL
0xC2	SMM_BASE
0xC3	SMMAP
0xC4	SMMCORE
0xC5	SMM_DISPATCH
0xC6	SMM_START
0xC7	SMM_RUNTIME
0xC8	SB_SMM_DISPATCH
0xC9	SMM_THUNK
0xCA	SMM_ACPI_SW_CHILD
0xCB	SMM_SB_S3_SAVE
0xCC	SMM_PLATFORM
0xCD 0xCE	SMM_GMCH_MBI SMM_FW_BLOCK_SERVICE
0xCF	SMM_VARIABLE
0xD0	SMM_IHISI
0xD1	SMM_INT15_MICROCODE
0xD2	SMM_PNP
0xD3	SMM_USB_LEGACY
0xD4	SMM_INT13_HDD
0xD5	SMM_INIT_PPM
0xD6	SMM_OHCI1394
0xD7	SMM_SECURITY_HDD_PASSWORD_SERVICE
0xD8	SMM_OEM_SERVICE
0xD9	SMM_PPM
0xDA	SMM_DIGITAL_THERMAL_SENSOR

Jumper and Connector Locations

Mainboard Top View

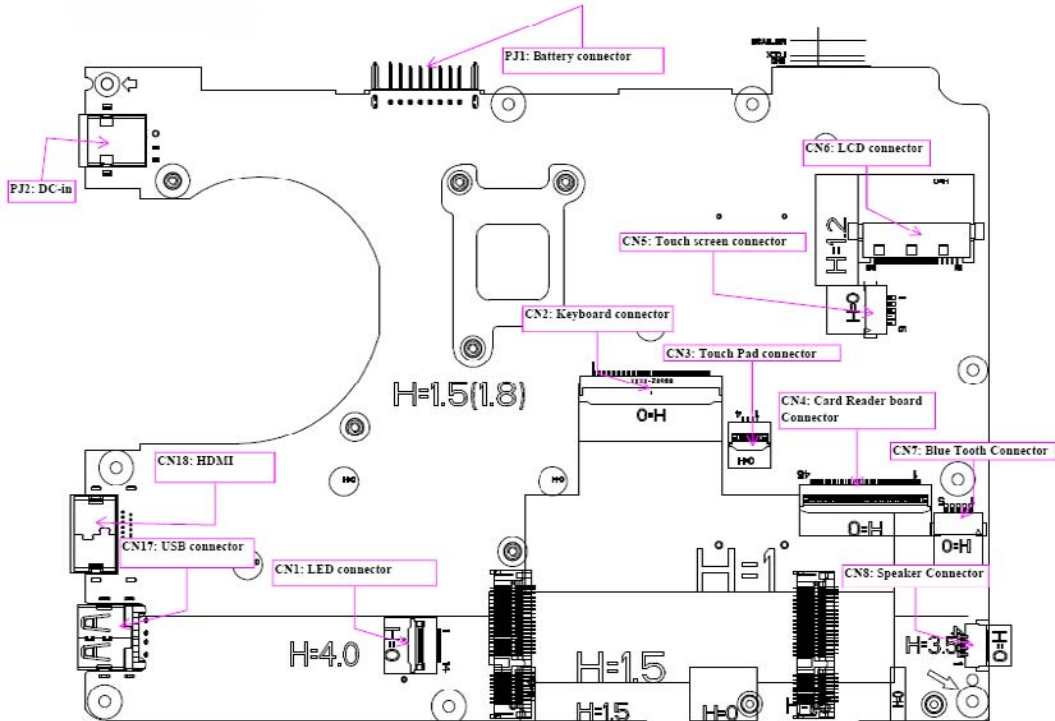

Item	Description	Item	Description
PJ2	DC-in	CN1	LED connector
PJ1	Battery connector	CN17	USB connector
CN6	LCD connector	CN18	HDMI
CN5	Touchscreen connector	CN2	Keyboard connector
CN7	Bluetooth connector	CN3	Touchpad connector
CN8	Speaker connector	CN4	Card reader board connector

Mainboard Bottom View

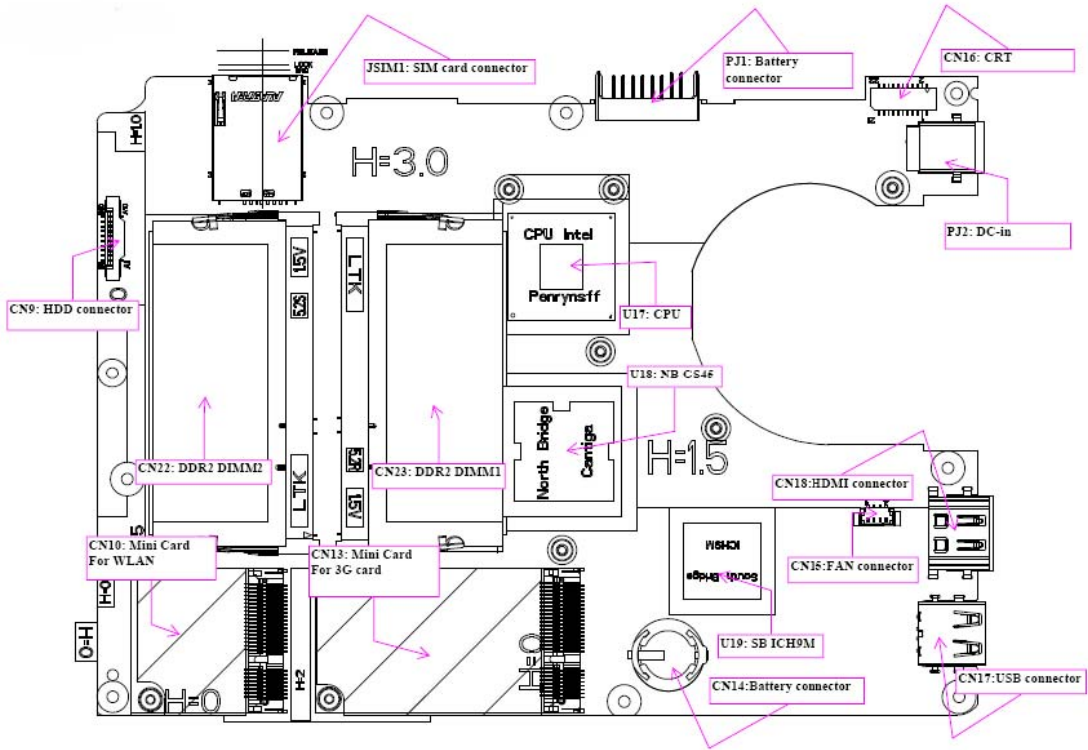

Item	Description	Item	Description
CN9	HDD connector	CN17	USB connector
JSIM1	SIM card connector	CN14	RTC battery connector
PJ1	Battery connector	CN13	Mini card for 3G
CN16	CRT	CN10	Mini card for WLAN
PJ2	DC-in	CN22	DDR2 DIMM2
U17	CPU	CN23	DDR2 DIMM1
U18	North Bridge GS45	U19	SB ICH9M
CN18	HDMI connector	CN15	Fan connector

Clearing Password Check and BIOS Recovery

This section provides a procedure for clearing the password and BIOS. The Hardware Open Gap on the main board clears the CMOS of all user settings and restores factory defaults.

Mainboard CMOS Discharge

Discharging the CMOS clears all user settings.

1. Disassemble the notebook and take out the Mainboard. See “Removing the Mainboard” on page 69.
2. Remove the RTC battery. See “Removing the RTC Battery” on page 73.

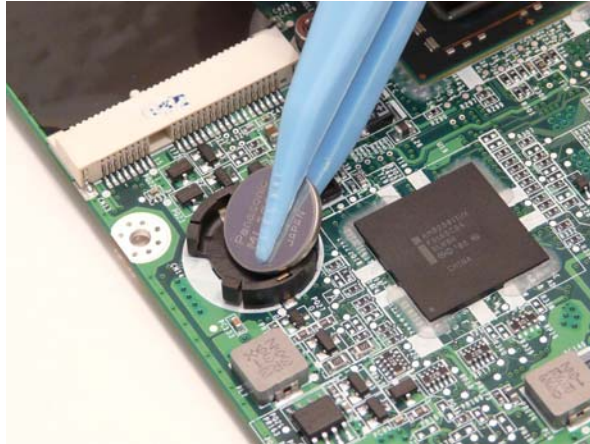

3. Turn the mainboard over, lift up the DIMM protective cover, and short the G3 pad.

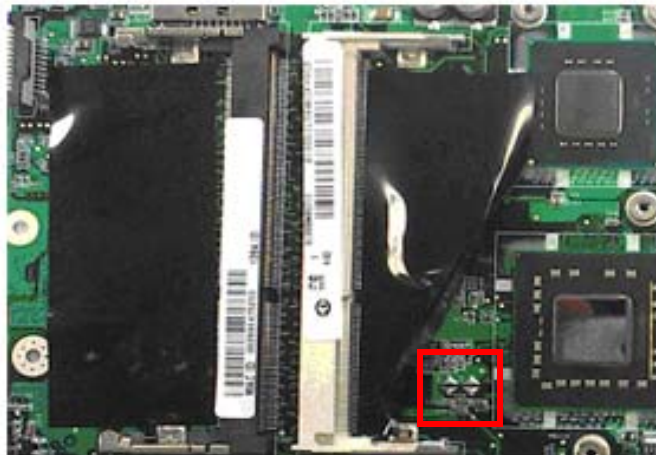

4. Reconnect the RTC battery and reassemble the unit.

BIOS Recovery by Crisis Disk

BIOS Recovery Boot Block

The BIOS Recovery Boot Block is a special block of BIOS. It is used to boot up the system with minimum BIOS initialization. Users can enable this feature to restore the BIOS firmware to the factory settings if a BIOS flash process fails.

BIOS Recovery Hotkey

The system provides a function hotkey: **Fn+Esc**, to enable the BIOS Recovery process when a system is powered on during BIOS POST. To use this function, it is strongly recommended to have the AC adapter and Battery present. If this function is enabled, the system will force the BIOS to enter a special BIOS block, called Boot Block.

Steps for BIOS Recovery from USB Storage

Before performing this procedure, prepare a Crisis USB key. The Crisis USB key can be made by executing the Crisis Disk program in a functioning system with a Windows XP, Vista or 7 OS.

IMPORTANT:The Crisis Disk program will overwrite all data on any drive that you use as a crisis disk.

Follow the steps below:

1. Modify the archive name from **ZE8 bios** to **ZE8X64.fd**
2. Save ROM file (file name: **ZE8X64.fd**) to the root directory of the USB storage.
3. Plug the USB storage into a USB port of the machine to have the crisis utility run on.
4. Remove the battery and AC adaptor of the machine.
5. While pressing the **Fn + ESC** buttons plug in the AC adaptor and then press Power. Keep pressing **Fn+ESC** till the power button flashes.
The LED of the USB flash disk flashes for three (3) to seven (7) minutes.
When CRISIS is complete, the system auto restarts with a workable BIOS.
6. Update the latest version BIOS for this machine by the regular BIOS flashing process.

FRU (Field Replaceable Unit) List

This chapter gives you the FRU (Field Replaceable Unit) listing in global configurations of the computer. Refer to this chapter whenever ordering for parts to repair or for RMA (Return Merchandise Authorization).

Please note that WHEN ORDERING FRU PARTS, you should check the most up-to-date information available on your regional web or channel. For whatever reasons a part number change is made, it will not be noted on the printed Service Guide. For ACER AUTHORIZED SERVICE PROVIDERS, your Acer office may have a DIFFERENT part number code from those given in the FRU list of this printed Service Guide. You MUST use the local FRU list provided by your regional Acer office to order FRU parts for repair and service of customer machines.

NOTE: To scrap or to return the defective parts, you should follow the local government ordinance or regulations on how to dispose it properly, or follow the rules set by your regional Acer office on how to return it.

Exploded Diagram

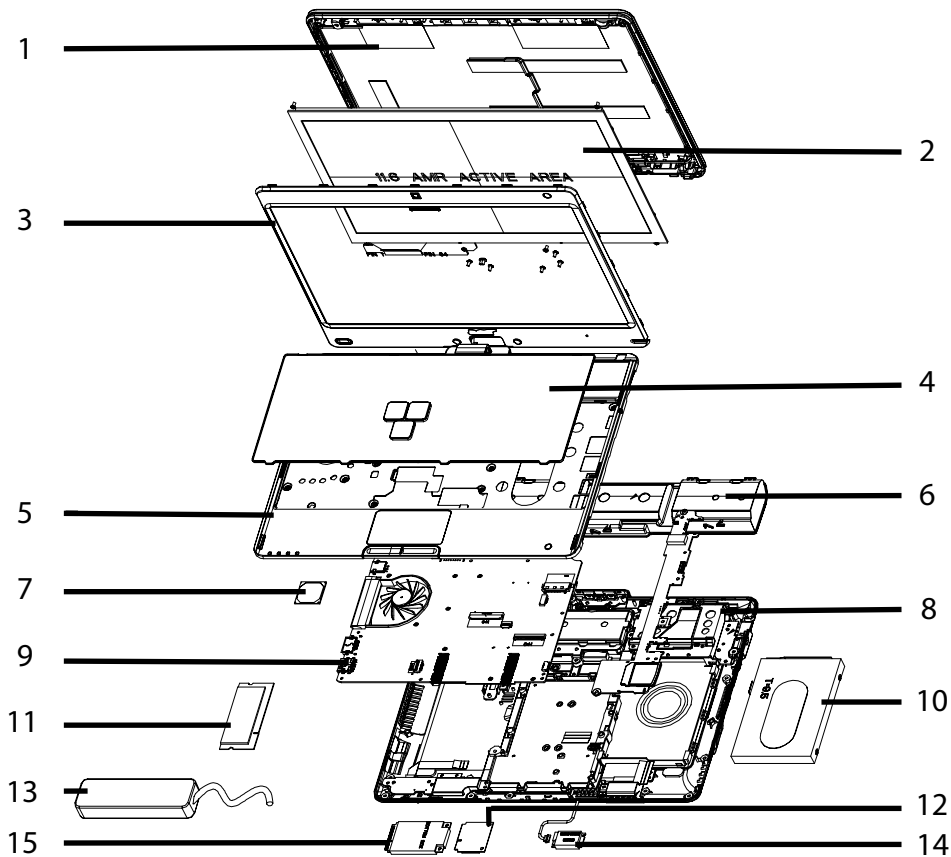

Item	Description	Acer Part No.
1	LCD cover	
2	LCD	LK.11605.003
3	LCD Bezel	
4	Keyboard Module	KB.I110A.026
5	Upper Cover	





Item	Description	Acer Part No.
6	Battery Module	
7	CPU	
8	Chassis Assembly	
9	PCB Assembly	
10	Hard Disk Drive Assembly	KH.16001.042
11	RAM DDR3 Module	KN.1GB0B.019
12	WLAN Module	KI.SPH01.005
13	Adapter	AP.03001.001
14	Bluetooth Module	BH.21100.004
15	3G Module	

Fru List

CATEGORY	PART NAME	ACER PART NO.
ADAPTER		
	ADAPTER DELTA 30W 19V 1.7X5.5X11 BLACK ADP-30JH BA LF	AP.03001.001
	ADAPTER LITE-ON 30W 1.7X5.5X11 BLACK PA-1300-04AC LF	AP.03003.001
	ADAPTER HIPRO 30W 19V 1.7X5.5X11 BLACK HP-A0301R3 B1LF LF	AP.0300A.001
BATTERY		
		
BOARD		
	Foxconn Bluetooth FOX BRM 2046 BT2.1	BT.21100.006 -> BH.21100.004
	Lan Intel WLAN 512AG_HMWG Shirley Peak 5100 MM#897072	KI.SPH01.005
	Lan Intel WLAN 512AN_HMWG Shirley Peak 5100 MM#895373	KI.SPH01.003
	Foxconn Wireless LAN Atheros HB93 1x2 BGN (HM)	NI.23600.046
TOUCH PANEL		
CCD		
		
CABLE		
	POWER CORD US 3PIN ROHS	27.TAXV7.001
	POWER CORD UK 3PIN	27.A03V7.004
CASE/COVER/BRACKET ASSEMBLY		

CATEGORY	PART NAME	ACER PART NO.
SATA HDD/HARD DISK DRIVE		
	HDD SEAGATE 2.5" 5400rpm 160GB ST9160314AS Wyatt SATA LF F/W:0001SDM1	KH.16001.042
	HDD TOSHIBA 2.5" 5400rpm 160GB MK1655GSX Libra SATA LF F/W: FG011J	KH.16004.006
	HDD HGST 2.5" 5400rpm 160GB HTS545016B9A300 Panther B SATA LF F/W:C60F Disk imbalance criteria = 0.014g-cm	KH.16007.026
	HDD WD 2.5" 5400rpm 160GB WD1600BEVT-22ZCT0 ML160 SATA LF F/W:11.01A11	KH.16008.022
	HDD SEAGATE 2.5" 5400rpm 250GB ST9250315AS Wyatt SATA LF F/W:0001SDM1	KH.25001.016
	HDD TOSHIBA 2.5" 5400rpm 250GB MK2555GSX Libra SATA LF F/W:FG001J	KH.25004.003
	HDD HGST 2.5" 5400rpm 250GB HTS545025B9A300 Panther B SATA LF F/W:C60F Disk imbalance criteria = 0.014g-cm	KH.25007.016
	HDD WD 2.5" 5400rpm 250GB WD2500BEVT-22ZCT0 ML160 SATA LF F/W:11.01A11	KH.25008.021
	HDD SEAGATE 2.5" 5400rpm 320GB ST9320325AS Wyatt SATA LF F/W:0001SDM1	KH.32001.017
	HDD HGST 2.5" 5400rpm 320GB HTS545032B9A300 Panther B SATA LF F/W:C60F Disk imbalance criteria = 0.014g-cm	KH.32007.008
	HDD WD 2.5" 5400rpm 320GB WD3200BEVT-22ZCT0 ML160 SATA LF F/W:11.01A11	KH.32008.013
	HDD SEAGATE 2.5" 5400rpm 500GB ST9500325AS Wyatt SATA LF F/W:0001SDM1	KH.50001.011
	HDD TOSHIBA 2.5" 5400rpm 500GB MK5055GSX Libra SATA LF F/W:FG001J	KH.50004.001
	HDD HGST 2.5" 5400rpm 500GB HTS545050B9A300 Panther B SATA LF F/W:C60F Disk imbalance criteria = 0.014g-cm	KH.50007.010
	HDD WD 2.5" 5400rpm 500GB WD5000BEVT-22ZAT0 ML250 SATA LF F/W:01.01A01	KH.50008.013

CATEGORY	PART NAME	ACER PART NO.
KEYBOARD		
	Keyboard ACER NT1T JM11 86KS Black Arabic Texture	KB.I110A.002
	Keyboard ACER NT1T JM11 87KS Black FR/Arabic Texture	KB.I110A.008
	Keyboard ACER NT1T JM11 87KS Black Brazilian Portuguese Texture	KB.I110A.004
	Keyboard ACER NT1T JM11 87KS Black Belgium Texture	KB.I110A.003
	Keyboard ACER NT1T JM11 87KS Black CZ/SK Texture	KB.I110A.005
	Keyboard ACER NT1T JM11 86KS Black Chinese Texture	KB.I110A.006
	Keyboard ACER NT1T JM11 87KS Black Danish Texture	KB.I110A.007
	Keyboard ACER NT1T JM11 87KS Black French Texture	KB.I110A.009
	Keyboard ACER NT1T JM11 87KS Black German Texture	KB.I110A.010
	Keyboard ACER NT1T JM11 86KS Black Greek Texture	KB.I110A.011
	Keyboard ACER NT1T JM11 87KS Black Hungarian Texture	KB.I110A.012
	Keyboard ACER NT1T JM11 87KS Black Italian Texture	KB.I110A.013
	Keyboard ACER NT1T JM11 91KS Black Japanese Texture	KB.I110A.014
	Keyboard ACER NT1T JM11 87KS Black Nordic Texture	KB.I110A.015
	Keyboard ACER NT1T JM11 87KS Black Norwegian Texture	KB.I110A.016
	Keyboard ACER NT1T JM11 87KS Black Portuguese Texture	KB.I110A.017
	Keyboard ACER NT1T JM11 86KS Black Russian Texture	KB.I110A.018
	Keyboard ACER NT1T JM11 87KS Black SLO/CRO Texture	KB.I110A.019
	Keyboard ACER NT1T JM11 87KS Black Spanish Texture	KB.I110A.020
	Keyboard ACER NT1T JM11 87KS Black Sweden Texture	KB.I110A.021
	Keyboard ACER NT1T JM11 87KS Black Swiss/G Texture	KB.I110A.022
	Keyboard ACER NT1T JM11 86KS Black Thailand Texture	KB.I110A.023
	Keyboard ACER NT1T JM11 87KS Black Turkish Texture	KB.I110A.024
	Keyboard ACER NT1T JM11 87KS Black UK Texture	KB.I110A.025
	Keyboard ACER NT1T JM11 86KS Black US International Texture	KB.I110A.026
	Keyboard ACER NT1T JM11 86KS Black US International w/ Hebrew Texture	KB.I110A.027
	Keyboard ACER NT1T JM11 87KS Black US w/ Canadian French Texture	KB.I110A.028

CATEGORY	PART NAME	ACER PART NO.
LCD PANEL		
	LED LCD AUO 11.6" WXGA Glare B116XW02 V0 1A (3G) LF 200nit 8ms 500:1	LK.11605.003
	LED LCD SAMSUNG 11.6" WXGA Glare LTN116AT01-A01 LF 200nit 8ms	LK.11606.001
	LED LCD LPL 11.6" WXGA Glare LP116WH1-TLA1 LF 200nit 8ms 500:1	LK.11608.001
	LED LCD CMO 11.6" WXGA Glare N116B6-L02 C2 LF 200nit 10ms 500:1	LK.1160D.005
MAINBOARD		
		
MEMORY		
		
	Memory SAMSUNG SO-DIMM DDRIII 1066 1GB M471B2874DZ1-CF8 LF	KN.1GB0B.019
	Memory SAMSUNG SO-DIMM DDRIII 1066 1GB M471B2873EH1-CF8 LF 64*16 0.055um	KN.1GB0B.028
	Memory SAMSUNG SO-DIMM DDRIII 1066 2GB M471B5673DZ1-CF8 LF	KN.2GB0B.005
	Memory SAMSUNG SO-DIMM DDRIII 1066 2GB M471B5673EH1-CF8 LF 128*8 0.055um	KN.2GB0B.012
	Memory HYNIX SO-DIMM DDRIII 1066 2GB HMT125S6BFR8C- G7 N0 LF 128*8 0.055um	KN.2GB0G.014
HEATSINK		
		
SPEAKER		
		
MISCELLANEOUS		

Screwlist

CATEGORY	PART NAME	ACER PART NO.
SCREW	SCREW M2.0*3.0-I(BKAG)(NYLOK IRON	86.ARE07.002
SCREW	SCREW 2.0*4.0	86.W0107.003
SCREW	SCREW M2.0*2.5-I(BUWZN)	86.TPK07.001
SCREW	SCREW M2*5-I(BZN)(NYLOK)	86.TG607.004
SCREW	SCREW M2.0*4-I(BZN)(NYLOK)IRON	86.S6507.003

Model Definition and Configuration

RO	Country	Acer Part No	Description	CPU
TWN	GCTWN	LX.PND02.003	AS1420P-232G25n W7HP64ATTW1 MC UMACbb 1*2G/250/BT/6L2.8/5R/ CB_bgn_0.3D_AU_TC11	CMSU230 0B
AAP	Australia/ New Zealand	LX.PND02.002	AS1420P-232G25n W7HP64ATAU1 MC UMACbb 1*2G/250/BT/6L2.8/5R/ CB_bgn_0.3D_AU_ES61	CMSU230 0B
WW	WW	S2.PND02.001	AS1420P-232G16n W7HP64AWW1 MC UMACbb 2*1G/160/BT/6L2.8/5R/ CB_bgn_0.3D_AU_ES62	CMSU230 0B
EME A	France	LX.PND02.001	AS1420P-233G25n W7HP64ATFR1 MC UMACbb 2G+1G/250/BT/6L2.8/5R/ CB_bgn_0.3D_AU_FR21	CMSU230 0B
EME A	Middle East	LX.PL902.032	AS1420P-232G25n EM W7HP64EMATME4 MC UMACKk 1*2G/250/BT/6L2.8/5R/ CB_bgn_0.3D_AU_ES61	CMSU230 0B
EME A	Middle East	LX.PL902.033	AS1420P-232G25n EM W7HP64EMATME2 MC UMACKk 1*2G/250/BT/6L2.8/5R/ CB_bgn_0.3D_AU_AR11	CMSU230 0B
EME A	Middle East	LX.PL902.038	AS1420P-232G25n EM W7HP64EMATME2 MC UMACKk 1*2G/250/BT/6L2.8/5R/ CB_bgn_0.3D_AU_ES61	CMSU230 0B
EME A	Middle East	LX.PL902.029	AS1420P-232G25n EM W7HP64EMATME3 MC UMACKk 1*2G/250/BT/6L2.8/5R/ CB_bgn_0.3D_AU_ES81	CMSU230 0B
EME A	Middle East	LX.PL902.035	AS1420P-232G25n EM W7HP64EMATME6 MC UMACKk 1*2G/250/BT/6L2.8/5R/ CB_bgn_0.3D_AU_ES61	CMSU230 0B
EME A	Middle East	LX.PL902.034	AS1420P-232G25n EM W7HP64EMATME2 MC UMACKk 1*2G/250/BT/6L2.8/5R/ CB_bgn_0.3D_AU_AR21	CMSU230 0B
EME A	Middle East	LX.PL902.040	AS1420P-232G25n EM W7HP64EMATME9 MC UMACKk 1*2G/250/BT/6L2.8/5R/ CB_bgn_0.3D_AU_ES81	CMSU230 0B
EME A	Turkey	LX.PL902.027	AS1420P-232G25n EM W7HP64EMATTR1 MC UMACKk 1*2G/250/BT/6L2.8/5R/ CB_bgn_0.3D_AU_TR31	CMSU230 0B
EME A	South Africa	LX.PL902.037	AS1420P-232G25n EM W7HP64EMATZA4 MC UMACKk 1*2G/250/BT/6L2.8/5R/ CB_bgn_0.3D_AU_ES61	CMSU230 0B
EME A	South Africa	LX.PL902.039	AS1420P-232G25n EM W7HP64EMATZA1 MC UMACKk 1*2G/250/BT/6L2.8/5R/ CB_bgn_0.3D_AU_ES81	CMSU230 0B
EME A	South Africa	LX.PL902.036	AS1420P-232G25n EM W7HP64EMATZA2 MC UMACKk 1*2G/250/BT/6L2.8/5R/ CB_bgn_0.3D_AU_ES61	CMSU230 0B

RO	Country	Acer Part No	Description	CPU
EME A	Spain	LX.PL902.045	AS1420P-232G25n W7HP64ATES1 MC UMACKk 1*2G/250/BT/6L2.8/5R/ CB_bgn_0.3D_AUk_ES51	CMSU230 0B
EME A	Russia	LX.PL902.044	AS1420P-232G25i W7HP64RUATRU1 MC UMACKk 1*2G/250/6L2.8/5R/ CB_bg_0.3D_AUk_RU11	CMSU230 0B
EME A	Russia	LX.PL902.043	AS1420P-232G16i W7HP64RUATRU1 MC UMACKk 1*2G/160/BT/6L2.8/5R/ CB_bg_0.3D_AU_RU11	CMSU230 0B
EME A	Russia	LX.PL902.042	AS1420P-232G25i W7HP64RUATRU1 MC UMACKk 1*2G/250/BT/6L2.8/5R/ CB_bg_0.3D_AU_RU11	CMSU230 0B
EME A	France	LX.PL902.041	AS1420P-233G25n W7HP64ATFR1 MC UMACKk 2G+1G/250/BT/6L2.8/5R/ CB_bgn_0.3D_AU_FR21	CMSU230 0B
EME A	Algeria	LX.PL902.031	AS1420P-232G25n EM W7HP64EMATDZ1 MC UMACKk 1*2G/250/BT/6L2.8/5R/ CB_bgn_0.3D_AU_ES81	CMSU230 0B
EME A	Middle East	LX.PL902.030	AS1420P-232G25n EM W7HP64EMATME4 MC UMACKk 1*2G/250/BT/6L2.8/5R/ CB_bgn_0.3D_AU_RU61	CMSU230 0B
EME A	Belgium	LX.PL902.028	AS1420P-232G25n W7HP64ATBE1 MC UMACKk 1*2G/250/BT/6L2.8/5R/ CB_bgn_0.3D_AU_NL11	CMSU230 0B
EME A	Germany	LX.PL902.026	AS1420P-232G25n W7HP64ATDE1 MC UMACKk 1*2G/250/BT/6L2.8/5R/ CB_bgn_0.3D_AU_DE11	CMSU230 0B
EME A	Eastern Europe	LX.PL902.025	AS1420P-232G25n W7HP64ATEU5 MC UMACKk 1*2G/250/BT/6L2.8/5R/ CB_bgn_0.3D_AU_RO11	CMSU230 0B
EME A	Hungary	LX.PL902.024	AS1420P-232G25n W7HP64ATHU1 MC UMACKk 1*2G/250/BT/6L2.8/5R/ CB_bgn_0.3D_AU_HU11	CMSU230 0B
EME A	Israel	LX.PL902.023	AS1420P-232G25n W7HP64ATIL1 MC UMACKk 1*2G/250/BT/6L2.8/5R/ CB_bgn_0.3D_AU_HE11	CMSU230 0B
EME A	Portugal	LX.PL902.022	AS1420P-232G25n W7HP64ATPT1 MC UMACKk 1*2G/250/BT/6L2.8/5R/ CB_bgn_0.3D_AU_PT11	CMSU230 0B
EME A	France	LX.PL902.021	AS1420P-232G25n W7HP64ATFR1 MC UMACKk 1*2G/250/BT/6L2.8/5R/ CB_bgn_0.3D_AU_FR21	CMSU230 0B
EME A	Italy	LX.PL902.020	AS1420P-232G25n W7HP64ATIT1 MC UMACKk 1*2G/250/BT/6L2.8/5R/ CB_bgn_0.3D_AU_IT11	CMSU230 0B
EME A	Austria	LX.PL902.019	AS1420P-232G25n W7HP64ATAT1 MC UMACKk 1*2G/250/BT/6L2.8/5R/ CB_bgn_0.3D_AU_DE61	CMSU230 0B
EME A	Latvia	LX.PL902.018	AS1420P-232G25n W7HP64ATLV1 MC UMACKk 1*2G/250/BT/6L2.8/5R/ CB_bgn_0.3D_AU_RU22	CMSU230 0B

RO	Country	Acer Part No	Description	CPU
EME A	Holland	LX.PL902.017	AS1420P-232G25n W7HP64ATNL1 MC UMACkk 1*2G/250/BT/6L2.8/5R/ CB_bgn_0.3D_AU_NL11	CMSU230 0B
EME A	Eastern Europe	LX.PL902.016	AS1420P-232G25n W7HP64ATEU7 MC UMACkk 1*2G/250/BT/6L2.8/5R/ CB_bgn_0.3D_AU_ENQ1	CMSU230 0B
EME A	Czech	LX.PL902.015	AS1420P-232G25n W7HP64ATCZ2 MC UMACkk 1*2G/250/BT/6L2.8/5R/ CB_bgn_0.3D_AU_SK11	CMSU230 0B
EME A	Denmark	LX.PL902.014	AS1420P-232G25n W7HP64ATDK2 MC UMACkk 1*2G/250/BT/6L2.8/5R/ CB_bgn_0.3D_AU_ENS1	CMSU230 0B
EME A	Cyprus	LX.PL902.013	AS1420P-232G25n W7HP64ATCY1 MC UMACkk 1*2G/250/BT/6L2.8/5R/ CB_bgn_0.3D_AU_ES61	CMSU230 0B
EME A	Eastern Europe	LX.PL902.012	AS1420P-232G25n W7HP64ATEU5 MC UMACkk 1*2G/250/BT/6L2.8/5R/ CB_bgn_0.3D_AU_PL71	CMSU230 0B
EME A	Eastern Europe	LX.PL902.011	AS1420P-232G25n W7HP64ATEU4 MC UMACkk 1*2G/250/BT/6L2.8/5R/ CB_bgn_0.3D_AU_SV21	CMSU230 0B
EME A	Poland	LX.PL902.010	AS1420P-232G25n W7HP64ATPL1 MC UMACkk 1*2G/250/BT/6L2.8/5R/ CB_bgn_0.3D_AU_PL11	CMSU230 0B
EME A	UK	LX.PL902.009	AS1420P-232G25n W7HP64ATGB1 MC UMACkk 1*2G/250/BT/6L2.8/5R/ CB_bgn_0.3D_AU_EN11	CMSU230 0B
EME A	Greece	LX.PL902.008	AS1420P-232G25n W7HP64ATGR1 MC UMACkk 1*2G/250/BT/6L2.8/5R/ CB_bgn_0.3D_AU_EL31	CMSU230 0B
EME A	Serbia/ Macedonia	LX.PL902.007	AS1420P-232G25n W7HP64ATCS1 MC UMACkk 1*2G/250/BT/6L2.8/5R/ CB_bgn_0.3D_AU_SL11	CMSU230 0B
EME A	Switzerland	LX.PL902.006	AS1420P-232G25n W7HP64ATCH1 MC UMACkk 1*2G/250/BT/6L2.8/5R/ CB_bgn_0.3D_AU_IT41	CMSU230 0B
EME A	Eastern Europe	LX.PL902.004	AS1420P-232G25n W7HP64ATEU7 MC UMACkk 1*2G/250/BT/6L2.8/5R/ CB_bgn_0.3D_AU_SL11	CMSU230 0B
EME A	Luxembour g	LX.PL902.005	AS1420P-232G25n W7HP64ATLU3 MC UMACkk 1*2G/250/BT/6L2.8/5R/ CB_bgn_0.3D_AU_IT41	CMSU230 0B
AAP	Australia/ New Zealand	LX.PL902.003	AS1420P-232G25n W7HP64ATAU1 MC UMACkk 1*2G/250/BT/6L2.8/5R/ CB_bgn_0.3D_AU_ES61	CMSU230 0B
TWN	GCTWN	LX.PL902.002	AS1420P-232G25n W7HP64ATTW1 MC UMACkk 1*2G/250/BT/6L2.8/5R/ CB_bgn_0.3D_AU_TC11	CMSU230 0B
WW	WW	S2.PL907.001	AS1420P-743G32n W7UT64AWW1 MC UMACkk 1G+2G/320/BT/6L2.8/5R/ CB_bgn_0.3D_AU_ES62	CM743B

RO	Country	Acer Part No	Description	CPU
WW	WW	S2.PL907.002	AS1420P-232G25n W7UT64AWW1 MC UMACkk 2*1G/250/BT/6L2.8/5R/ CB_bgn_0.3D_AU_ES62	CMSU230 0B
WW	WW	S2.PNE02.001	AS1420P-232G25n W7HP64AWW1 MC UMACrr 2*1G/250/BT/6L2.8/5R/ CB_bgn_0.3D_AU_ES62	CMSU230 0B
WW	WW	S2.PNG02.001	AS1420P-232G25n W7HP64AWW1 MC UMAGCbb 2*1G/250/BT/6L2.8/5R/ CB_bgn_0.3D_E77W_AU_ES62	CMSU230 0B
PA	USA	LX.PNF07.001	AS1420P-232G25n W7UT64AUS1 MC UMAGCkk 1*2G/250/BT/6L2.8/5R/ CB_bgn_0.3D_E77MS_AU_ENP1	CMSU230 0B
WW	WW	S2.PNF02.001	AS1420P-232G25n W7HP64AWW1 MC UMAGCkk 1*2G/250/BT/6L2.8/5R/ CB_bgn_0.3D_E77W_AU_ES62	CMSU230 0B
WW	WW	S2.PNH02.001	AS1420P-741G25n W7HP64AWW1 MC UMAGCrr 1*1G/250/BT/6L2.8/5R/ CB_bgn_0.3D_E77W_AU_ES62	CM743B
TWN	GCTWN	LX.PNB02.013	AS1820PTZ-412G50n W7HP64ATTW1 MC UMACbb 1*2G/500_L/BT/6L2.8/5R/ CB_bgn_0.3D_AU_TC11	PMDSU41 00B
TWN	GCTWN	LX.PNB02.014	AS1820PTZ-412G32n W7HP64ATTW1 MC UMACbb 1*2G/320/BT/6L2.8/5R/ CB_bgn_0.3D_AU_TC11	PMDSU41 00B
AAP	Malaysia	LX.PNB02.012	AS1820PTZ-412G32n EM W7HP64EMATMY1 MC UMACbb 1*2G/320/ BT/6L2.8/5R/CB_bgn_0.3D_AU_ES61	PMDSU41 00B
AAP	Malaysia	LX.PNB02.011	AS1820PTZ-411G25n EM W7HP64EMATMY1 MC UMACbb 1*1G/250/ BT/6L2.8/5R/CB_bgn_0.3D_AU_ES61	PMDSU41 00B
CHIN A	Hong Kong	LX.PNB02.015	AS1820PTZ-412G32n W7HP64ATHK2 MC UMACbb 1*2G/320/BT/6L2.8/5R/ CB_bgn_0.3D_AUb_ZH34	PMDSU41 00B
CHIN A	China	LX.PNB02.016	AS1820PTZ-414G32n W7HP64SCATCN1 MC UMACbb 2*2G/320/BT/6L2.8/5R/ CB_bgn_0.3D_AUb_SC14	PMDSU41 00B
AAP	Singapore	LX.PNB02.010	AS1820PTZ-414G32n W7HP64ATSG1 MC UMACbb 2*2G/320/BT/6L2.8/5R/ CB_bgn_0.3D_AU_ES61	PMDSU41 00B
AAP	Singapore	LX.PNB02.009	AS1820PTZ-412G32n W7HP64ATSG1 MC UMACbb 1*2G/320/BT/6L2.8/5R/ CB_bgn_0.3D_AU_ES61	PMDSU41 00B
AAP	Singapore	LX.PNB02.008	AS1820PTZ-414G25n W7HP64ATSG1 MC UMACbb 2*2G/250/BT/6L2.8/5R/ CB_bgn_0.3D_AU_ES61	PMDSU41 00B
AAP	Singapore	LX.PNB02.007	AS1820PTZ-413G16n W7HP64ATSG1 MC UMACbb 2G+1G/160/BT/6L2.8/5R/ CB_bgn_0.3D_AU_ES61	PMDSU41 00B
AAP	Singapore	LX.PNB02.006	AS1820PTZ-413G25n W7HP64ATSG1 MC UMACbb 2G+1G/250/BT/6L2.8/5R/ CB_bgn_0.3D_AU_ES61	PMDSU41 00B

RO	Country	Acer Part No	Description	CPU
AAP	Singapore	LX.PNB02.005	AS1820PTZ-413G32n W7HP64ATSG1 MC UMACbb 2G+1G/320/BT/6L2.8/5R/ CB_bgn_0.3D_AU_ES61	PMDSU41 00B
AAP	Singapore	LX.PNB02.004	AS1820PTZ-412G25n W7HP64ATSG1 MC UMACbb 1*2G/250/BT/6L2.8/5R/ CB_bgn_0.3D_AU_ES61	PMDSU41 00B
AAP	Singapore	LX.PNB02.003	AS1820PTZ-412G16n W7HP64ATSG1 MC UMACbb 1*2G/160/BT/6L2.8/5R/ CB_bgn_0.3D_AU_ES61	PMDSU41 00B
EME A	Spain	LX.PNB02.002	AS1820PTZ-413G32n W7HP64ATES1 MC UMACbb 2G+1G/320/BT/6L2.8/5R/ CB_bgn_0.3D_AU_ES51	PMDSU41 00B
WW	WW	S2.PNB02.001	AS1820PTZ-414G25n W7HP64AWW1 MC UMACbb 2*2G/250/BT/6L2.8/5R/ CB_bgn_0.3D_AU_ES62	PMDSU41 00B
EME A	France	LX.PNB02.001	AS1820PTZ-414G32n W7HP64ATFR1 MC UMACbb 2*2G/320/BT/6L2.8/5R/ CB_bgn_0.3D_AU_FR21	PMDSU41 00B
EME A	France	LX.PNA02.001	AS1820PTZ-414G32n W7HP64ATFR1 MC UMACkk 2*2G/320/BT/6L2.8/5R/ CB_bgn_0.3D_AU_FR21	PMDSU41 00B
CHIN A	Hong Kong	LX.PNA02.016	AS1820PTZ-412G32n W7HP64ATHK2 MC UMACkk 1*2G/320/BT/6L2.8/5R/ CB_bgn_0.3D_AUk_ZH34	PMDSU41 00B
AAP	Vietnam	LX.PNA02.011	AS1820PTZ-412G25n EM W7HP64EMATVN1 MC UMACkk 1*2G/250/ BT/6L2.8/5R/CB_bgn_0.3D_AU_ES61	PMDSU41 00B
AAP	Malaysia	LX.PNA02.012	AS1820PTZ-411G25n EM W7HP64EMATMY1 MC UMACkk 1*1G/250/ BT/6L2.8/5R/CB_bgn_0.3D_AU_ES61	PMDSU41 00B
AAP	Malaysia	LX.PNA02.013	AS1820PTZ-412G32n EM W7HP64EMATMY1 MC UMACkk 1*2G/320/ BT/6L2.8/5R/CB_bgn_0.3D_AU_ES61	PMDSU41 00B
CHIN A	China	LX.PNA02.015	AS1820PTZ-414G32n W7HP64SCATCN1 MC UMACkk 2*2G/320/BT/6L2.8/5R/ CB_bgn_0.3D_AUk_SC14	PMDSU41 00B
EME A	Switzerland	LX.PNA02.014	AS1820PTZ-414G32n W7HP64ATCH1 MC UMACkk 2*2G/320/BT/6L2.8/5R/ CB_bgn_0.3D_AU_IT41	PMDSU41 00B
AAP	Singapore	LX.PNA02.005	AS1820PTZ-412G32n W7HP64ATSG1 MC UMACkk 1*2G/320/BT/6L2.8/5R/ CB_bgn_0.3D_AU_ES61	PMDSU41 00B
AAP	Singapore	LX.PNA02.010	AS1820PTZ-414G25n W7HP64ATSG1 MC UMACkk 2*2G/250/BT/6L2.8/5R/ CB_bgn_0.3D_AU_ES61	PMDSU41 00B
AAP	Singapore	LX.PNA02.009	AS1820PTZ-414G32n W7HP64ATSG1 MC UMACkk 2*2G/320/BT/6L2.8/5R/ CB_bgn_0.3D_AU_ES61	PMDSU41 00B
AAP	Singapore	LX.PNA02.008	AS1820PTZ-413G32n W7HP64ATSG1 MC UMACkk 2G+1G/320/BT/6L2.8/5R/ CB_bgn_0.3D_AU_ES61	PMDSU41 00B

RO	Country	Acer Part No	Description	CPU
AAP	Singapore	LX.PNA02.007	AS1820PTZ-413G25n W7HP64ATSG1 MC UMACkk 2G+1G/250/BT/6L2.8/5R/ CB_bgn_0.3D_AU_ES61	PMDSU41 00B
AAP	Singapore	LX.PNA02.006	AS1820PTZ-413G16n W7HP64ATSG1 MC UMACkk 2G+1G/160/BT/6L2.8/5R/ CB_bgn_0.3D_AU_ES61	PMDSU41 00B
AAP	Singapore	LX.PNA02.004	AS1820PTZ-412G25n W7HP64ATSG1 MC UMACkk 1*2G/250/BT/6L2.8/5R/ CB_bgn_0.3D_AU_ES61	PMDSU41 00B
AAP	Singapore	LX.PNA02.003	AS1820PTZ-412G16n W7HP64ATSG1 MC UMACkk 1*2G/160/BT/6L2.8/5R/ CB_bgn_0.3D_AU_ES61	PMDSU41 00B
WW	WW	S2.PNA02.001	AS1820PTZ-412G50n W7HP64AWW1 MC UMACkk 2*1G/500_L/BT/6L2.8/5R/ CB_bgn_0.3D_AU_ES62	PMDSU41 00B
EME A	Spain	LX.PNA02.002	AS1820PTZ-413G32n W7HP64ATES1 MC UMACkk 2G+1G/320/BT/6L2.8/5R/ CB_bgn_0.3D_AU_ES51	PMDSU41 00B
CHIN A	Hong Kong	LX.PNC02.014	AS1820PTZ-412G32n W7HP64ATHK2 MC UMACrr 1*2G/320/BT/6L2.8/5R/ CB_bgn_0.3D_AUr_ZH34	PMDSU41 00B
AAP	Malaysia	LX.PNC02.012	AS1820PTZ-411G25n EM W7HP64EMATMY1 MC UMACrr 1*1G/250/ BT/6L2.8/5R/CB_bgn_0.3D_AU_ES61	PMDSU41 00B
AAP	Malaysia	LX.PNC02.011	AS1820PTZ-412G32n EM W7HP64EMATMY1 MC UMACrr 1*2G/320/ BT/6L2.8/5R/CB_bgn_0.3D_AU_ES61	PMDSU41 00B
CHIN A	China	LX.PNC02.013	AS1820PTZ-414G32n W7HP64SCATCN1 MC UMACrr 2*2G/320/BT/6L2.8/5R/ CB_bgn_0.3D_AUr_SC14	PMDSU41 00B
AAP	Singapore	LX.PNC02.010	AS1820PTZ-414G32n W7HP64ATSG1 MC UMACrr 2*2G/320/BT/6L2.8/5R/ CB_bgn_0.3D_AU_ES61	PMDSU41 00B
AAP	Singapore	LX.PNC02.009	AS1820PTZ-414G25n W7HP64ATSG1 MC UMACrr 2*2G/250/BT/6L2.8/5R/ CB_bgn_0.3D_AU_ES61	PMDSU41 00B
AAP	Singapore	LX.PNC02.008	AS1820PTZ-413G16n W7HP64ATSG1 MC UMACrr 2G+1G/160/BT/6L2.8/5R/ CB_bgn_0.3D_AU_ES61	PMDSU41 00B
AAP	Singapore	LX.PNC02.007	AS1820PTZ-413G25n W7HP64ATSG1 MC UMACrr 2G+1G/250/BT/6L2.8/5R/ CB_bgn_0.3D_AU_ES61	PMDSU41 00B
AAP	Singapore	LX.PNC02.005	AS1820PTZ-412G32n W7HP64ATSG1 MC UMACrr 1*2G/320/BT/6L2.8/5R/ CB_bgn_0.3D_AU_ES61	PMDSU41 00B
AAP	Singapore	LX.PNC02.006	AS1820PTZ-413G32n W7HP64ATSG1 MC UMACrr 2G+1G/320/BT/6L2.8/5R/ CB_bgn_0.3D_AU_ES61	PMDSU41 00B
AAP	Singapore	LX.PNC02.004	AS1820PTZ-412G25n W7HP64ATSG1 MC UMACrr 1*2G/250/BT/6L2.8/5R/ CB_bgn_0.3D_AU_ES61	PMDSU41 00B

RO	Country	Acer Part No	Description	CPU
AAP	Singapore	LX.PNC02.003	AS1820PTZ-412G16n W7HP64ATSG1 MC UMACrr 1*2G/160/BT/6L2.8/5R/ CB_bgn_0.3D_AU_ES61	PMDSU41 00B
EME A	Spain	LX.PNC02.002	AS1820PTZ-413G32n W7HP64ATES1 MC UMACrr 2G+1G/320/BT/6L2.8/5R/ CB_bgn_0.3D_AU_ES51	PMDSU41 00B
WW	WW	S2.PNC02.001	AS1820PTZ-414G25n W7HP64AWW1 MC UMACrr 2*2G/250/BT/6L2.8/5R/ CB_bgn_0.3D_AU_ES62	PMDSU41 00B
EME A	France	LX.PNC02.001	AS1820PTZ-414G32n W7HP64ATFR1 MC UMACrr 2*2G/320/BT/6L2.8/5R/ CB_bgn_0.3D_AU_FR21	PMDSU41 00B
WW	WW	S2.PN802.001	AS1820PTZ-414G25n W7HP64AWW1 MC UMAGCbb 2*2G/250/BT/6L2.8/5R/ CB_bgn_0.3D_E77W_AU_ES62	PMDSU41 00B
AAP	Australia/ New Zealand	LX.PLM02.004	AS1820PTZ-412G25n W7HP64ATAU1 MC UMAGCkk 1*2G/250/BT/6L2.8/5R/ CB_bgn_0.3D_E77W_AU_ES61	PMDSU41 00B
AAP	Australia/ New Zealand	LX.PLM02.003	AS1820PTZ-412G32n W7HP64ATAU1 MC UMAGCkk 1*2G/320/BT/6L2.8/5R/ CB_bgn_0.3D_E77W_AU_ES61	PMDSU41 00B
AAP	Australia/ New Zealand	LX.PLM02.002	AS1820PTZ-413G25n W7HP64ATAU1 MC UMAGCkk 2G+1G/250/BT/6L2.8/5R/ CB_bgn_0.3D_E77W_AU_ES61	PMDSU41 00B
AAP	Australia/ New Zealand	LX.PLM02.001	AS1820PTZ-414G32n W7HP64ATAU1 MC UMAGCkk 2*2G/320/BT/6L2.8/5R/ CB_bgn_0.3D_E77W_AU_ES61	PMDSU41 00B
WW	WW	S2.PLM07.001	AS1820PTZ-414G32n W7UT64AWW1 MC UMAGCkk 2*2G/320/BT/6L2.8/5R/ CB_bgn_0.3D_E77W_AU_ES62	PMDSU41 00B
WW	WW	S2.PN902.001	AS1820PTZ-413G25n W7HP64AWW1 MC UMAGCrr 2G+1G/250/BT/6L2.8/5R/ CB_bgn_0.3D_E77W_AU_ES62	PMDSU41 00B
TWN	GCTWN	LX.PN402.013	AS1820PT-732G50n W7HP64ATTW1 MC UMACbb 1*2G/500_L/BT/6L2.8/5R/ CB_n2_0.3D_AU_TC11	C2DSU730 0B
CHIN A	Hong Kong	LX.PN402.014	AS1820PT-732G32n W7HP64ATHK2 MC UMACbb 1*2G/320/BT/6L2.8/5R/ CB_n2_0.3D_AU_ZH34	C2DSU730 0B
AAP	Australia/ New Zealand	LX.PN402.002	AS1820PT-732G25n W7HP64ATAU1 MC UMACbb 1*2G/250/BT/6L2.8/5R/ CB_n2_0.3D_AU_ES61	C2DSU730 0B
AAP	Singapore	LX.PN402.012	AS1820PT-733G32n W7HP64ATSG1 MC UMACbb 2G+1G/320/BT/6L2.8/5R/ CB_n2_0.3D_AU_ES61	C2DSU730 0B
AAP	Singapore	LX.PN402.011	AS1820PT-732G32n W7HP64ATSG1 MC UMACbb 1*2G/320/BT/6L2.8/5R/ CB_n2_0.3D_AU_ES61	C2DSU730 0B
AAP	Singapore	LX.PN402.010	AS1820PT-732G25n W7HP64ATSG1 MC UMACbb 1*2G/250/BT/6L2.8/5R/ CB_n2_0.3D_AU_ES61	C2DSU730 0B

RO	Country	Acer Part No	Description	CPU
AAP	Singapore	LX.PN402.009	AS1820PT-734G32n W7HP64ATSG1 MC UMACbb 2*2G/320/BT/6L2.8/5R/ CB_n2_0.3D_AU_ES61	C2DSU730 0B
AAP	Singapore	LX.PN402.008	AS1820PT-734G25n W7HP64ATSG1 MC UMACbb 2*2G/250/BT/6L2.8/5R/ CB_n2_0.3D_AU_ES61	C2DSU730 0B
AAP	Singapore	LX.PN402.007	AS1820PT-733G25n W7HP64ATSG1 MC UMACbb 2G+1G/250/BT/6L2.8/5R/ CB_n2_0.3D_AU_ES61	C2DSU730 0B
AAP	Singapore	LX.PN402.006	AS1820PT-732G16n W7HP64ATSG1 MC UMACbb 1*2G/160/BT/6L2.8/5R/ CB_n2_0.3D_AU_ES61	C2DSU730 0B
AAP	Singapore	LX.PN402.005	AS1820PT-733G16n W7HP64ATSG1 MC UMACbb 2G+1G/160/BT/6L2.8/5R/ CB_n2_0.3D_AU_ES61	C2DSU730 0B
EME A	France	LX.PN402.004	AS1820PT-734G50n W7HP64ATFR1 MC UMACbb 2*2G/500_L/BT/6L2.8/5R/ CB_n2_0.3D_AU_FR21	C2DSU730 0B
WW	WW	S2.PN402.001	AS1820PT-732G25n W7HP64AWW1 MC UMACbb 1*2G/250/BT/6L2.8/5R/ CB_n2_0.3D_AU_ES62	C2DSU730 0B
PA	Canada	LX.PN402.003	AS1820PT-733G32n W7HP64ATCA2 MC UMACbb 2G+1G/320/BT/6L2.8/5R/ CB_n2_0.3D_AU_FR81	C2DSU730 0B
EME A	France	LX.PN402.001	AS1820PT-734G32n W7HP64ATFR1 MC UMACbb 2*2G/320/BT/6L2.8/5R/ CB_n2_0.3D_AU_FR21	C2DSU730 0B
EME A	Middle East	LX.PN302.029	AS1820PT-734G32n EM W7HP64EMATME4 MC UMACKk 2*2G/320/BT/6L2.8/5R/ CB_n2_0.3D_AU_ES61	C2DSU730 0B
EME A	Middle East	LX.PN302.034	AS1820PT-734G32n EM W7HP64EMATME2 MC UMACKk 2*2G/320/BT/6L2.8/5R/ CB_n2_0.3D_AU_AR11	C2DSU730 0B
EME A	Middle East	LX.PN302.036	AS1820PT-734G32n EM W7HP64EMATME2 MC UMACKk 2*2G/320/BT/6L2.8/5R/ CB_n2_0.3D_AU_ES61	C2DSU730 0B
EME A	Middle East	LX.PN302.025	AS1820PT-734G32n EM W7HP64EMATME3 MC UMACKk 2*2G/320/BT/6L2.8/5R/ CB_n2_0.3D_AU_ES81	C2DSU730 0B
EME A	Middle East	LX.PN302.035	AS1820PT-734G32n EM W7HP64EMATME6 MC UMACKk 2*2G/320/BT/6L2.8/5R/ CB_n2_0.3D_AU_ES61	C2DSU730 0B
EME A	Middle East	LX.PN302.030	AS1820PT-734G32n EM W7HP64EMATME2 MC UMACKk 2*2G/320/BT/6L2.8/5R/ CB_n2_0.3D_AU_AR21	C2DSU730 0B
EME A	Middle East	LX.PN302.038	AS1820PT-734G32n EM W7HP64EMATME9 MC UMACKk 2*2G/320/BT/6L2.8/5R/ CB_n2_0.3D_AU_ES81	C2DSU730 0B
EME A	Turkey	LX.PN302.033	AS1820PT-734G32n EM W7HP64EMATTR1 MC UMACKk 2*2G/320/BT/6L2.8/5R/ CB_n2_0.3D_AU_TR31	C2DSU730 0B

RO	Country	Acer Part No	Description	CPU
EME A	South Africa	LX.PN302.032	AS1820PT-734G32n EM W7HP64EMATZA4 MC UMACKk 2*2G/320/BT/6L2.8/5R/ CB_n2_0.3D_AU_ES61	C2DSU730 0B
EME A	South Africa	LX.PN302.037	AS1820PT-734G32n EM W7HP64EMATZA1 MC UMACKk 2*2G/320/BT/6L2.8/5R/ CB_n2_0.3D_AU_ES81	C2DSU730 0B
EME A	South Africa	LX.PN302.031	AS1820PT-734G32n EM W7HP64EMATZA2 MC UMACKk 2*2G/320/BT/6L2.8/5R/ CB_n2_0.3D_AU_ES61	C2DSU730 0B
CHIN A	China	LX.PN302.057	AS1820PT-734G32n W7HP64SCATCN1 MC UMACKk 2*2G/320/BT/6L2.8/5R/ CB_n2_0.3D_AUK_SC14	C2DSU730 0B
CHIN A	Hong Kong	LX.PN302.058	AS1820PT-732G32n W7HP64ATHK2 MC UMACKk 1*2G/320/BT/6L2.8/5R/ CB_n2_0.3D_AUK_ZH34	C2DSU730 0B
AAP	Australia/ New Zealand	LX.PN302.043	AS1820PT-732G25n W7HP64ATAU1 MC UMACKk 1*2G/250/BT/6L2.8/5R/ CB_n2_0.3D_AU_ES61	C2DSU730 0B
EME A	Germany	LX.PN302.056	AS1820PT-734G32n W7HP64ATDE1 MC UMACKk 2*2G/320/BT/6L2.8/5R/ CB_n2_0.3D_AUK_DE11	C2DSU730 0B
EME A	Switzerland	LX.PN302.055	AS1820PT-734G50n W7HP64ATCH1 MC UMACKk 2*2G/500_L/BT/6L2.8/5R/ CB_n2_0.3D_AU_IT41	C2DSU730 0B
AAP	Singapore	LX.PN302.054	AS1820PT-734G32n W7HP64ATSG1 MC UMACKk 2*2G/320/BT/6L2.8/5R/ CB_n2_0.3D_AU_ES61	C2DSU730 0B
AAP	Singapore	LX.PN302.053	AS1820PT-732G32n W7HP64ATSG1 MC UMACKk 1*2G/320/BT/6L2.8/5R/ CB_n2_0.3D_AU_ES61	C2DSU730 0B
AAP	Indonesia	LX.PN302.052	AS1820PT-732G50n EM W7HP64EMATID1 MC UMACKk 1*2G/500_L/BT/6L2.8/5R/ CB_n2_0.3D_AU_ID21	C2DSU730 0B
AAP	Singapore	LX.PN302.050	AS1820PT-733G32n W7HP64ATSG1 MC UMACKk 2G+1G/320/BT/6L2.8/5R/ CB_n2_0.3D_AU_ES61	C2DSU730 0B
AAP	Singapore	LX.PN302.051	AS1820PT-734G25n W7HP64ATSG1 MC UMACKk 2*2G/250/BT/6L2.8/5R/ CB_n2_0.3D_AU_ES61	C2DSU730 0B
AAP	Singapore	LX.PN302.049	AS1820PT-732G16n W7HP64ATSG1 MC UMACKk 1*2G/160/BT/6L2.8/5R/ CB_n2_0.3D_AU_ES61	C2DSU730 0B
AAP	Singapore	LX.PN302.048	AS1820PT-733G25n W7HP64ATSG1 MC UMACKk 2G+1G/250/BT/6L2.8/5R/ CB_n2_0.3D_AU_ES61	C2DSU730 0B
AAP	Singapore	LX.PN302.047	AS1820PT-733G16n W7HP64ATSG1 MC UMACKk 2G+1G/160/BT/6L2.8/5R/ CB_n2_0.3D_AU_ES61	C2DSU730 0B
AAP	Singapore	LX.PN302.046	AS1820PT-732G25n W7HP64ATSG1 MC UMACKk 1*2G/250/BT/6L2.8/5R/ CB_n2_0.3D_AU_ES61	C2DSU730 0B

RO	Country	Acer Part No	Description	CPU
AAP	Singapore	LX.PN302.045	AS1820PT-734G50n W7HP64ATSG1 MC UMACkk 2*2G/500_L/BT/6L2.8/5R/ CB_n2_0.3D_AU_ES61	C2DSU730 0B
EME A	UK	LX.PN302.044	AS1820PT-734G25n W7HP64ATGB1 MC UMACkk 2*2G/250/BT/6L2.8/5R/ CB_n2_0.3D_AU_EN11	C2DSU730 0B
EME A	France	LX.PN302.042	AS1820PT-734G50n W7HP64ATFR1 MC UMACkk 2*2G/500_L/BT/6L2.8/5R/ CB_n2_0.3D_AU_FR21	C2DSU730 0B
WW	WW	S2.PN302.001	AS1820PT-734G32n W7HP64AWW1 MC UMACkk 2*2G/320/BT/6L2.8/5R/ CB_n2_0.3D_AU_ES62	C2DSU730 0B
PA	Canada	LX.PN302.041	AS1820PT-733G32n W7HP64ATCA2 MC UMACkk 2G+1G/320/BT/6L2.8/5R/ CB_n2_0.3D_AU_FR81	C2DSU730 0B
EME A	Middle East	LX.PN302.027	AS1820PT-734G32n EM W7HP64EMATME4 MC UMACkk 2*2G/320/BT/6L2.8/5R/ CB_n2_0.3D_AU_RU61	C2DSU730 0B
EME A	Russia	LX.PN302.040	AS1820PT-734G32i W7HP64RUATRU1 MC UMACkk 2*2G/320/BT/6L2.8/5R/ CB_abg_0.3D_AU_RU11	C2DSU730 0B
EME A	Algeria	LX.PN302.028	AS1820PT-734G32n EM W7HP64EMATDZ1 MC UMACkk 2*2G/320/BT/6L2.8/5R/ CB_n2_0.3D_AU_ES81	C2DSU730 0B
EME A	Ukraine	LX.PN302.039	AS1820PT-734G32i W7HP64RUATUK1 MC UMACkk 2*2G/320/BT/6L2.8/5R/ CB_abg_0.3D_AU_RU61	C2DSU730 0B
EME A	France	LX.PN302.018	AS1820PT-734G32n W7HP64ATFR1 MC UMACkk 2*2G/320/BT/6L2.8/5R/ CB_n2_0.3D_AU_FR21	C2DSU730 0B
EME A	Germany	LX.PN302.024	AS1820PT-734G32n W7HP64ATDE1 MC UMACkk 2*2G/320/BT/6L2.8/5R/ CB_n2_0.3D_AU_DE11	C2DSU730 0B
EME A	Belgium	LX.PN302.026	AS1820PT-734G32n W7HP64ATBE1 MC UMACkk 2*2G/320/BT/6L2.8/5R/ CB_n2_0.3D_AU_NL11	C2DSU730 0B
EME A	Israel	LX.PN302.021	AS1820PT-734G32n W7HP64ATIL1 MC UMACkk 2*2G/320/BT/6L2.8/5R/ CB_n2_0.3D_AU_HE11	C2DSU730 0B
EME A	Austria	LX.PN302.016	AS1820PT-734G32n W7HP64ATAT1 MC UMACkk 2*2G/320/BT/6L2.8/5R/ CB_n2_0.3D_AU_DE61	C2DSU730 0B
EME A	Eastern Europe	LX.PN302.023	AS1820PT-734G32n W7HP64ATEU5 MC UMACkk 2*2G/320/BT/6L2.8/5R/ CB_n2_0.3D_AU_RO11	C2DSU730 0B
EME A	Portugal	LX.PN302.019	AS1820PT-734G32n W7HP64ATPT1 MC UMACkk 2*2G/320/BT/6L2.8/5R/ CB_n2_0.3D_AU_PT11	C2DSU730 0B
EME A	Hungary	LX.PN302.022	AS1820PT-734G32n W7HP64ATHU1 MC UMACkk 2*2G/320/BT/6L2.8/5R/ CB_n2_0.3D_AU_HU11	C2DSU730 0B

RO	Country	Acer Part No	Description	CPU
EME A	Spain	LX.PN302.020	AS1820PT-734G32n W7HP64ATES1 MC UMACkk 2*2G/320/BT/6L2.8/5R/ CB_n2_0.3D_AU_ES51	C2DSU730 0B
EME A	Italy	LX.PN302.017	AS1820PT-734G32n W7HP64ATIT1 MC UMACkk 2*2G/320/BT/6L2.8/5R/ CB_n2_0.3D_AU_IT11	C2DSU730 0B
EME A	Eastern Europe	LX.PN302.009	AS1820PT-734G32n W7HP64ATEU5 MC UMACkk 2*2G/320/BT/6L2.8/5R/ CB_n2_0.3D_AU_PL71	C2DSU730 0B
EME A	Holland	LX.PN302.014	AS1820PT-734G32n W7HP64ATNL1 MC UMACkk 2*2G/320/BT/6L2.8/5R/ CB_n2_0.3D_AU_NL11	C2DSU730 0B
EME A	Czech	LX.PN302.012	AS1820PT-734G32n W7HP64ATCZ2 MC UMACkk 2*2G/320/BT/6L2.8/5R/ CB_n2_0.3D_AU_SK11	C2DSU730 0B
EME A	Latvia	LX.PN302.015	AS1820PT-734G32n W7HP64ATLV1 MC UMACkk 2*2G/320/BT/6L2.8/5R/ CB_n2_0.3D_AU_RU22	C2DSU730 0B
EME A	Eastern Europe	LX.PN302.013	AS1820PT-734G32n W7HP64ATEU7 MC UMACkk 2*2G/320/BT/6L2.8/5R/ CB_n2_0.3D_AU_ENQ1	C2DSU730 0B
EME A	Eastern Europe	LX.PN302.008	AS1820PT-734G32n W7HP64ATEU4 MC UMACkk 2*2G/320/BT/6L2.8/5R/ CB_n2_0.3D_AU_SV21	C2DSU730 0B
EME A	Cyprus	LX.PN302.010	AS1820PT-734G32n W7HP64ATCY1 MC UMACkk 2*2G/320/BT/6L2.8/5R/ CB_n2_0.3D_AU_ES61	C2DSU730 0B
EME A	Denmark	LX.PN302.011	AS1820PT-734G32n W7HP64ATDK2 MC UMACkk 2*2G/320/BT/6L2.8/5R/ CB_n2_0.3D_AU_ENS1	C2DSU730 0B
EME A	Poland	LX.PN302.007	AS1820PT-734G32n W7HP64ATPL1 MC UMACkk 2*2G/320/BT/6L2.8/5R/ CB_n2_0.3D_AU_PL11	C2DSU730 0B
EME A	Switzerland	LX.PN302.003	AS1820PT-734G32n W7HP64ATCH1 MC UMACkk 2*2G/320/BT/6L2.8/5R/ CB_n2_0.3D_AU_IT41	C2DSU730 0B
EME A	Greece	LX.PN302.005	AS1820PT-734G32n W7HP64ATGR1 MC UMACkk 2*2G/320/BT/6L2.8/5R/ CB_n2_0.3D_AU_EL31	C2DSU730 0B
EME A	Luxembour g	LX.PN302.002	AS1820PT-734G32n W7HP64ATLU3 MC UMACkk 2*2G/320/BT/6L2.8/5R/ CB_n2_0.3D_AU_IT41	C2DSU730 0B
EME A	UK	LX.PN302.006	AS1820PT-734G32n W7HP64ATGB1 MC UMACkk 2*2G/320/BT/6L2.8/5R/ CB_n2_0.3D_AU_EN11	C2DSU730 0B
EME A	Eastern Europe	LX.PN302.001	AS1820PT-734G32n W7HP64ATEU7 MC UMACkk 2*2G/320/BT/6L2.8/5R/ CB_n2_0.3D_AU_SL11	C2DSU730 0B
EME A	Serbia/ Macedonia	LX.PN302.004	AS1820PT-734G32n W7HP64ATCS1 MC UMACkk 2*2G/320/BT/6L2.8/5R/ CB_n2_0.3D_AU_SL11	C2DSU730 0B

RO	Country	Acer Part No	Description	CPU
AAP	Philippines	LX.PN502.011	AS1820PT-732G25n EM W7HP64EMATPH1 MC UMACrr 1*2G/250/BT/6L2.8/5R/ CB_n2_0.3D_AU_ES61	C2DSU730 0B
CHIN A	Hong Kong	LX.PN502.013	AS1820PT-732G32n W7HP64ATHK2 MC UMACrr 1*2G/320/BT/6L2.8/5R/ CB_n2_0.3D_AUr_ZH34	C2DSU730 0B
CHIN A	China	LX.PN502.012	AS1820PT-734G32n W7HP64SCATCN1 MC UMACrr 2*2G/320/BT/6L2.8/5R/ CB_n2_0.3D_AUr_SC14	C2DSU730 0B
AAP	Singapore	LX.PN502.010	AS1820PT-734G25n W7HP64ATSG1 MC UMACrr 2*2G/250/BT/6L2.8/5R/ CB_n2_0.3D_AU_ES61	C2DSU730 0B
AAP	Singapore	LX.PN502.009	AS1820PT-734G32n W7HP64ATSG1 MC UMACrr 2*2G/320/BT/6L2.8/5R/ CB_n2_0.3D_AU_ES61	C2DSU730 0B
AAP	Singapore	LX.PN502.008	AS1820PT-733G32n W7HP64ATSG1 MC UMACrr 2G+1G/320/BT/6L2.8/5R/ CB_n2_0.3D_AU_ES61	C2DSU730 0B
AAP	Singapore	LX.PN502.007	AS1820PT-732G32n W7HP64ATSG1 MC UMACrr 1*2G/320/BT/6L2.8/5R/ CB_n2_0.3D_AU_ES61	C2DSU730 0B
AAP	Singapore	LX.PN502.006	AS1820PT-732G25n W7HP64ATSG1 MC UMACrr 1*2G/250/BT/6L2.8/5R/ CB_n2_0.3D_AU_ES61	C2DSU730 0B
AAP	Singapore	LX.PN502.005	AS1820PT-733G25n W7HP64ATSG1 MC UMACrr 2G+1G/250/BT/6L2.8/5R/ CB_n2_0.3D_AU_ES61	C2DSU730 0B
AAP	Singapore	LX.PN502.004	AS1820PT-733G16n W7HP64ATSG1 MC UMACrr 2G+1G/160/BT/6L2.8/5R/ CB_n2_0.3D_AU_ES61	C2DSU730 0B
AAP	Singapore	LX.PN502.003	AS1820PT-732G16n W7HP64ATSG1 MC UMACrr 1*2G/160/BT/6L2.8/5R/ CB_n2_0.3D_AU_ES61	C2DSU730 0B
EME A	France	LX.PN502.002	AS1820PT-734G50n W7HP64ATFR1 MC UMACrr 2*2G/500_L/BT/6L2.8/5R/ CB_n2_0.3D_AU_FR21	C2DSU730 0B
WW	WW	S2.PN502.001	AS1820PT-734G50n W7HP64AWW1 MC UMACrr 2*2G/500_L/BT/6L2.8/5R/ CB_n2_0.3D_AU_ES62	C2DSU730 0B
EME A	France	LX.PN502.001	AS1820PT-734G32n W7HP64ATFR1 MC UMACrr 2*2G/320/BT/6L2.8/5R/ CB_n2_0.3D_AU_FR21	C2DSU730 0B
EME A	Germany	LX.PN602.001	AS1820PT-734G50n W7HP64ATDE1 MC UMAGCbb 2*2G/500_L/BT/6L2.8/5R/ CB_n2_0.3D_E77W_AU_DE11	C2DSU730 0B
WW	WW	S2.PN602.001	AS1820PT-733G32n W7HP64AWW1 MC UMAGCbb 2G+1G/320/BT/6L2.8/5R/ CB_n2_0.3D_E77W_AU_ES62	C2DSU730 0B
AAP	Australia/ New Zealand	LX.PLN02.009	AS1820PT-732G32n W7HP64ATAU1 MC UMAGCkk 1*2G/320/BT/6L2.8/5R/ CB_n2_0.3D_E77W_AU_ES61	C2DSU730 0B

RO	Country	Acer Part No	Description	CPU
AAP	Australia/ New Zealand	LX.PLN02.008	AS1820PT-732G25n W7HP64ATAU1 MC UMAGCkk 1*2G/250/BT/6L2.8/5R/ CB_n2_0.3D_E77W_AU_ES61	C2DSU730 0B
EME A	UK	LX.PLN02.010	AS1820PT-733G16n W7HP64ATGB1 MC UMAGCkk 2G+1G/160/BT/6L2.8/5R/ CB_n2_0.3D_E77W_AUk_EN11	C2DSU730 0B
EME A	Germany	LX.PLN02.007	AS1820PT-734G50n W7HP64ATDE1 MC UMAGCkk 2*2G/500_L/BT/6L2.8/5R/ CB_n2_0.3D_E77W_AU_DE11	C2DSU730 0B
AAP	Australia/ New Zealand	LX.PLN02.006	AS1820PT-734G50n W7HP64ATAU1 MC UMAGCkk 2*2G/500_L/BT/6L2.8/5R/ CB_n2_0.3D_E77W_AU_ES61	C2DSU730 0B
AAP	Australia/ New Zealand	LX.PLN02.005	AS1820PT-734G32n W7HP64ATAU1 MC UMAGCkk 2*2G/320/BT/6L2.8/5R/ CB_n2_0.3D_E77W_AU_ES61	C2DSU730 0B
AAP	Thailand	LX.PLN02.004	AS1820PT-734G50n EM W7HP64EMATTH1 MC UMAGCkk 2*2G/500_L/BT/6L2.8/5R/ CB_n2_0.3D_G2K_AU_TH41	C2DSU730 0B
AAP	Thailand	LX.PLN02.003	AS1820PT-734G50n EM W7HP64EMATTH1 MC UMAGCkk 2*2G/500_L/BT/6L2.8/5R/ CB_n2_0.3D_E77W_AU_TH41	C2DSU730 0B
TWN	GCTWN	LX.PLN02.002	AS1820PT-732G32n W7HP64ATTW1 MC UMAGCkk 1*2G/320/BT/6L2.8/5R/ CB_n2_0.3D_G2K_AU_TC11	C2DSU730 0B
AAP	Singapore	LX.PLN02.001	AS1820PT-734G32n W7HP64ATSG1 MC UMAGCkk 2*2G/320/BT/6L2.8/5R/ CB_n2_0.3D_G2K_AU_ES61	C2DSU730 0B
WW	WW	S2.PLN07.001	AS1820PT-734G50n W7UT64AWW1 MC UMAGCkk 2*2G/500_L/BT/6L2.8/5R/ CB_n2_0.3D_G2K_AU_ES62	C2DSU730 0B
EME A	Germany	LX.PN702.001	AS1820PT-734G50n W7HP64ATDE1 MC UMAGCrr 2*2G/500_L/BT/6L2.8/5R/ CB_n2_0.3D_E77W_AU_DE11	C2DSU730 0B
WW	WW	S2.PN702.001	AS1820PT-734G50i W7HP64AWW1 MC UMAGCrr 2*2G/500_L/BT/6L2.8/5R/ CB_abg_0.3D_E77W_AU_ES62	C2DSU730 0B

Test Compatible Components

This computer's compatibility is tested and verified by Acer's internal testing department. All of its system functions are tested under Windows 7 environment.

Refer to the following lists for components, adapter cards, and peripherals which have passed these tests. Regarding configuration, combination and test procedures, please refer to the Aspire one series Compatibility Test Report released by the Acer Mobile System Testing Department.

BRAND	Type	Description
3G		
	UNDP-1	3G UNDP-1
Huawei	EM770W-MSFT	Huawei 3G EM770W-MSFT
Huawei	EM770W	Huawei EM770W
A cover		
	ABS UV Black	A cover ABS UV Black
	ABS UV Blue	A cover ABS UV Blue
	ABS UV Red	ABS UV Red
Accessory		
	JM12_MS Protection Bag	Accessory JM12_MS Protection Bag
Adapter		
DELTA	30W	Adapter DELTA 30W 19V 1.7x5.5x11 Black ADP-30JH BA LF
HIPRO	30W	Adapter HIPRO 30W 19V 1.7x5.5x11 Black HP-A0301R3 B1LF LF
LITE-ON	30W	Adapter LITE-ON 30W 19V 1.7x5.5x11 Black PA-1300-04AC LF
Audio Codec		
Realtek	ALC269X	Realtek Audio Codec ALC269X
B cover		
	Normal w/Camera	Normal w/Camera
Battery		
SANYO	6CELL2.8	Battery SANYO UM-2009F Li-Ion 3S2P SANYO 6 cell 5600mAh Main COMMON
SIMPLO	6CELL2.8	Battery SIMPLO UM-2009F Li-Ion 3S2P SAMSUNG 6 cell 5600mAh Main COMMON ID:UM09F70
Bluetooth		
Foxconn	BT 2.1	Foxconn Bluetooth BRM 2046 BT2.1 (T60H928.33) f/w:861
Camera		
Chicony	0.3M LDV	Chicony 0.3M LDV Lilac_3GA (CNF9042-G)
Chicony	0.3M LDV	Chicony Camera Lilac_2G
Liteon	0.3M LDV	Liteon 0.3M LDV Lily_2GA
Liteon	0.3M LDV	Liteon Camera Lily_2G
Suyin	0.3M LDV	Suyin Camera Rose_2G
Card Reader		
	5 in 1-Build in	5 in 1-Build in MS, MS Pro, SD, SC, XD

BRAND	Type	Description
CPU		
INTEL	CMSU2300B	CPU Intel Celeron SU2300 BGA 1.2G 1M 800 10W R-0
INTEL	PMDSU4100B	CPU Intel Core2Dual SU4100 2M 800
INTEL	C2DSU7300B	CPU Intel Core2Dual SU7300 3M 800 R-0
G sensor		
	LIS33DETR	G sensor LIS33DETR
HDD		
HGST	N160GB5.4KS	HDD HGST 2.5" 5400rpm 160GB HTS545016B9A300 Panther B SATA LF F/W:C60F Disk imbalance criteria = 0.014g-cm
HGST	N250GB5.4KS	HDD HGST 2.5" 5400rpm 250GB HTS545025B9A300 Panther B SATA LF F/W:C60F Disk imbalance criteria = 0.014g-cm
HGST	N320GB5.4KS	HDD HGST 2.5" 5400rpm 320GB HTS545032B9A300 Panther B SATA LF F/W:C60F Disk imbalance criteria = 0.014g-cm
HGST	N500GB5.4KS	HDD HGST 2.5" 5400rpm 500GB HTS545050B9A300 Panther B SATA LF F/W:C60F Disk imbalance criteria = 0.014g-cm
SEAGATE	N160GB5.4KS	HDD SEAGATE 2.5" 5400rpm 160GB ST9160314AS Wyatt SATA LF F/W:0001SDM1
SEAGATE	N250GB5.4KS	HDD SEAGATE 2.5" 5400rpm 250GB ST9250315AS Wyatt SATA LF F/W:0001SDM1
SEAGATE	N320GB5.4KS	HDD SEAGATE 2.5" 5400rpm 320GB ST9320325AS Wyatt SATA LF F/W:0001SDM1
SEAGATE	N500GB5.4KS	HDD SEAGATE 2.5" 5400rpm 500GB ST9500325AS Wyatt SATA LF F/W:0001SDM1
TOSHIBA	N160GB5.4KS	HDD TOSHIBA 2.5" 5400rpm 160GB MK1655GSX Libra SATA LF F/W: FG011J
TOSHIBA	N250GB5.4KS	HDD TOSHIBA 2.5" 5400rpm 250GB MK2555GSX Libra SATA LF F/W:FG001J
TOSHIBA	N500GB5.4KS	HDD TOSHIBA 2.5" 5400rpm 500GB MK5055GSX Libra SATA LF F/W:FG001J
WD	N160GB5.4KS	HDD WD 2.5" 5400rpm 160GB WD1600BEVT-22ZCT0 ML160 SATA LF F/W:11.01A11
WD	N250GB5.4KS	HDD WD 2.5" 5400rpm 250GB WD2500BEVT-22ZCT0 ML160 SATA LF F/W:11.01A11
WD	N320GB5.4KS	HDD WD 2.5" 5400rpm 320GB WD3200BEVT-22ZCT0 ML160 SATA LF F/W:11.01A11
WD	N500GB5.4KS	HDD WD 2.5" 5400rpm 500GB WD5000BEVT-22ZAT0 ML250 SATA LF F/W:01.01A01
ACER	NT1T	Keyboard ACER NT-1T JV11 Internal 11 Standard Black NONE Texture
LAN		
Atheros	AR8131L	Atheros AR8131L
LCD		
AUO	NLED11.6WXGAG	LED LCD AUO 11.6" WXGA Glare B116XW02 V0 1A (3G) LF 200nit 8ms 500:1
CMO	NLED11.6WXGAG	LED LCD CMO 11.6" WXGA Glare N116B6-L02 C2 LF 200nit 10ms 500:1
LPL	NLED11.6WXGAG	LED LCD LPL 11.6" WXGA Glare LP116WH1-TLA1 LF 200nit 8ms 500:1

BRAND	Type	Description
SAMSUNG	NLED11.6WXGAG	LED LCD SAMSUNG 11.6" WXGA Glare LTN116AT01-A01 LF 200nit 8ms
MEM		
A-DATA	SO2GBIII10	Memory A-DATA SO-DIMM DDRIII 1066 2GB HY7YG1B1674ZM LF 128*8 0.065um
ELPIDA	SO1GBIII10	Memory ELPIDA SO-DIMM DDRIII 1066 1GB EBJ10UE8BDS0-AE-F LF 128*8 0.065um
ELPIDA	SO2GBIII10	Memory ELPIDA SO-DIMM DDRIII 1066 2GB EBJ21UE8BDS0-AE-F LF 128*8 0.065um
HYNIX	SO1GBIII10	Memory HYNIX SO-DIMM DDRIII 1066 1GB HMT112S6BFR6C-G7 N0 LF 64*16 0.055um
HYNIX	SO2GBIII10	Memory HYNIX SO-DIMM DDRIII 1066 2GB HMT125S6BFR8C-G7 N0 LF 128*8 0.055um
MICRON	SO1GBIII10	Memory MICRON SO-DIMM DDRIII 1066 1GB MT8JSF12864HZ-1G1F1 LF 128*8 0.065um
MICRON	SO2GBIII10	Memory MICRON SO-DIMM DDRIII 1066 2GB MT16JSF25664HZ-1G1F1 LF 128*8 0.065um
SAMSUNG	SO1GBIII10	Memory SAMSUNG SO-DIMM DDRIII 1066 1GB M471B2873EH1-CF8 LF 64*16 0.055um
SAMSUNG	SO2GBIII10	Memory SAMSUNG SO-DIMM DDRIII 1066 2GB M471B5673EH1-CF8 LF 128*8 0.055um
NB Chipset		
INTEL	GS45	NB Chipset Intel CS GS45NB
SB Chipset		
INTEL	ICH9M-SFFE	SB Chipset Intel CS AM82801IUX MM#898134
Software		
	McAfee	Antivirus application McAfee
VGA Chip		
None	UMA	UMA (Intel)
WiFi Antenna		
WNC	PIFA	PIFA
Wiping Cloth		
	Wiping Cloth	Wiping Cloth Wiping Cloth BAP31-41-51 Wiping Cloth 15x15cm
Wireless LAN		
INTEL	INT1000H	Lan Intel WLAN 112BN.HMWG MM#903341
INTEL	SP1x2HABG	Lan Intel WLAN 512AG_HMWG Shirley Peak 5100 MM#897072
INTEL	SP1x2HMW	Lan Intel WLAN 512AN_HMWG Shirley Peak 5100 MM#895373

MS Compatibility Test Report

Test Item	Level	Driver Initial	Graceful Removal	Hot Insert	Surprise Removal	Cold Insert	S3 Removal	S3 Insert	Hibernate Removal	Hibernate Insert	Reboot	Bug NO. / Comment	Expected Result
Express Card													
1394													
AboCom Express Card[54 1394A 800Mbps]	L1	N/A	N/A	N/A	N/A	N/A	N/A	N/A	N/A	N/A	N/A	no support	1.Plug in Express card. And connect a 1394 HDD device 2.Make sure it can read and write.
AboCom Express Card[54 1394B 800Mbps]	L1	N/A	N/A	N/A	N/A	N/A	N/A	N/A	N/A	N/A	N/A	no support	
APIOTEX COMBO Express Card Adapter	L1	N/A	N/A	N/A	N/A	N/A	N/A	N/A	N/A	N/A	N/A	no support	
USB 2.0													
APIOTEX USB2.0 Quad Express Card Adapter	L1	N/A	N/A	N/A	N/A	N/A	N/A	N/A	N/A	N/A	N/A	no support	1.Plug in Express card. 2.Plug in USB device and make sure it can works.
APIOTEX COMBO Express Card Adapter	L1	N/A	N/A	N/A	N/A	N/A	N/A	N/A	N/A	N/A	N/A	no support	
eSATA II													
eSATA II Dual Ports Express Card	L1	N/A	N/A	N/A	N/A	N/A	N/A	N/A	N/A	N/A	N/A	no support	1.Plug in Express card. 2.make sure it can works.
APIOTEK eSATAII 300 Express Caed Adaptor	L1	N/A	N/A	N/A	N/A	N/A	N/A	N/A	N/A	N/A	N/A	no support	
Card Reader													
APIOTEK 24 in 1 Express Card Adapter	L1	N/A	N/A	N/A	N/A	N/A	N/A	N/A	N/A	N/A	N/A	no support	1.Plug in Express card. should be a driver letter pop in my computer taskbar. 2.Plug in SD, MS, or XD make sure it can read and writer.
ExpressCard Reader 12 in 1	L1	N/A	N/A	N/A	N/A	N/A	N/A	N/A	N/A	N/A	N/A	no support	
GigaLAN													
Maxell Express card[34 GigabitEthernet adapter	L1	N/A	N/A	N/A	N/A	N/A	N/A	N/A	N/A	N/A	N/A	no support	1.Plug in Express card. should be a driver letter pop in my computer taskbar. 2.Plug in a Lan line, and connect to Lan, and make sure it can upload and download.
3G	L1	N/A	N/A	N/A	N/A	N/A	N/A	N/A	N/A	N/A	N/A	no support	
BandLuxe C100	L1	N/A	N/A	N/A	N/A	N/A	N/A	N/A	N/A	N/A	N/A	no support	1. Check no yellow bang" in device manager. 2. Connect to Internet and download a 5MB file. 3. Connect to Saturn and download a 100MB file.
TV tuner	L1	N/A	N/A	N/A	N/A	N/A	N/A	N/A	N/A	N/A	N/A	no support	
AVerMedia AVerTV Hybrid Express card	L1	N/A	N/A	N/A	N/A	N/A	N/A	N/A	N/A	N/A	N/A	no support	1.Plug in TV tuner card. 2.make sure it can works.
AVerMedia AVerTV DVB-T Express	L1	N/A	N/A	N/A	N/A	N/A	N/A	N/A	N/A	N/A	N/A	no support	
Display Port													
External Monitor - CRT													
View Sonic PF775	L1	Pass	Pass	Pass	Pass	Pass	Pass	Pass	Pass	Pass	Pass		Please follow CRT monitor test procedure.
Graphic Series GT775	L1	Pass	Pass	Pass	Pass	Pass	Pass	Pass	Pass	Pass	Pass		
Philip 109P	L1	Pass	Pass	Pass	Pass	Pass	Pass	Pass	Pass	Pass	Pass		
Dell 21"	L1	Pass	Pass	Pass	Pass	Pass	Pass	Pass	Pass	Pass	Pass		
External Monitor - LCD													
COMPAQ FP 7317 17" (1024*768)(QSMC)	L1	Pass	Pass	Pass	Pass	Pass	Pass	Pass	Pass	Pass	Pass		Please follow CRT monitor test procedure
Gateway FPD1730 17"(1280*1024)(QSMC)	L1	Pass	Pass	Pass	Pass	Pass	Pass	Pass	Pass	Pass	Pass		
View Sonic (1680*1050)	L1	Pass	Pass	Pass	Pass	Pass	Pass	Pass	Pass	Pass	Pass		
CMV CM-930D 17" (1280*1024)	L1	Pass	Pass	Pass	Pass	Pass	Pass	Pass	Pass	Pass	Pass		
ACER AL2423W (1920*1200)	L1	Pass	Pass	Pass	Pass	Pass	Pass	Pass	Pass	Pass	Pass		
Gateway TV 26" (1280*768)	L1	Pass	Pass	Pass	Pass	Pass	Pass	Pass	Pass	Pass	Pass		
Toshiba TV 37HL869 (1366*768)	L1	Pass	Pass	Pass	Pass	Pass	Pass	Pass	Pass	Pass	Pass		
External Monitor - DVI													
VP730b 17" (1280*1024)(QSMC)	L1	N/A	N/A	N/A	N/A	N/A	N/A	N/A	N/A	N/A	N/A	no support	Please follow CRT monitor test procedure
CMV CM-930D 17" LCD (1280*1024)	L1	N/A	N/A	N/A	N/A	N/A	N/A	N/A	N/A	N/A	N/A	no support	
Gateway TV 26" (1280*768)	L1	N/A	N/A	N/A	N/A	N/A	N/A	N/A	N/A	N/A	N/A	no support	
ACER AL2423W (1920*1200)	L1	N/A	N/A	N/A	N/A	N/A	N/A	N/A	N/A	N/A	N/A	no support	
Projector													
3M Projector	L1	Pass	Pass	Pass	Pass	Pass	Pass	Pass	Pass	Pass	Pass		1. Hot plug the projector. Use hot key to switch the displ
TV													
FERGUSON DV3(QSMC)	L1	N/A	N/A	N/A	N/A	N/A	N/A	N/A	N/A	N/A	N/A	no support	1. Check TV display quality. No serious flicker. 2. Check NTSC/PAL mode and no garbage or flicker. 3. Check if hot key is supported.
SONY Trinitron 14" VPL-CX5	L1	N/A	N/A	N/A	N/A	N/A	N/A	N/A	N/A	N/A	N/A	no support	
LCD TV													
Gateway TV 26" (1280*768)	L1	Pass	Pass	Pass	Pass	Pass	Pass	Pass	Pass	Pass	Pass		1. Check TV display quality. No serious flicker.
Toshiba TV 37HL869 (1366*768)	L1	Pass	Pass	Pass	Pass	Pass	Pass	Pass	Pass	Pass	Pass		
HD TV (HDMI)													
Toshiba TV 37HL869 (1366*768)	L1	N/A	N/A	N/A	N/A	N/A	N/A	N/A	N/A	N/A	N/A	no support	1. Check TV display quality. No serious flicker.
Acer AT4220 (1920*1200)	L1	N/A	N/A	N/A	N/A	N/A	N/A	N/A	N/A	N/A	N/A	no support	

Test Item	Level	Driver Initial	Graceful Removal	Hot Insert	Surprise Removal	Cold Insert	S3 Removal	S3 Insert	Hibernate Removal	Hibernate Insert	Reboot	Bug NO. / Comment	Expected Result
USB Port													
Keyboard													
i-rocks KR-6910 KeyPad	L1	Pass	Pass	Pass	Pass	Pass	Pass	Pass	Pass	Pass	Pass		1. Hot plug in a USB keyboard. 2. Check no yellow ban "!" in device manager. 3. Open wordpad or notepad. 4. Check all characters.
Atake USB keyboard	L1	Pass	Pass	Pass	Pass	Pass	Pass	Pass	Pass	Pass	Pass		
Logitech USB Keyboard	L1	Pass	Pass	Pass	Pass	Pass	Pass	Pass	Pass	Pass	Pass		
WINTEK USB Keyboard	L1	Pass	Pass	Pass	Pass	Pass	Pass	Pass	Pass	Pass	Pass		
Mouse													
Microsoft Basic Optical Mouse v2.0	L1	Pass	Pass	Pass	Pass	Pass	Pass	Pass	Pass	Pass	Pass		1. Hot plug in a USB mouse. 2. Check no yellow ban "!" in device manager. 3. Move mouse and make sure mouse move smooth, no delay. (Make a circle)
Microsoft IntelliMouse Explorer 3.0 USB	L1	Pass	Pass	Pass	Pass	Pass	Pass	Pass	Pass	Pass	Pass		
Microsoft IntelliMouse Explorer 4.0 USB	L1	Pass	Pass	Pass	Pass	Pass	Pass	Pass	Pass	Pass	Pass		
Printer													
HPC7280 PHOTOSMART Printer	L1	Pass	Pass	Pass	Pass	Pass	Pass	Pass	Pass	Pass	Pass	inboxdriver	1. Check no yellow bang in device manager. 2. Print a test page.
HP deskjet 3535 Printer	L1	Pass	Pass	Pass	Pass	Pass	Pass	Pass	Pass	Pass	Pass	inboxdriver	
Scanner													
Epson V750 USB Scanner	L3	Pass	Pass	Pass	Pass	Pass	Pass	Pass	Pass	Pass	Pass		1. Install driver and check device manager. No yellow bang"!". 2. Double click "HP PrecisionScan" which is on the desktop. 3. Start to scan the photos.
Speaker													
OZAKI 5.1CH-IN-2SPK Digital Sound	L1	Pass	Pass	Pass	Pass	Pass	Pass	Pass	Pass	Pass	Pass		1. Hot plug the USB speaker. There is no yellow ban in device manager. 2. Play audio CD, the audio should play from USB speaker. 3. Check audio quality.
KINYO Portable Speaker PS-292	L1	Pass	Pass	Pass	Pass	Pass	Pass	Pass	Pass	Pass	Pass		
Joystick													
Logitech WingMan RUMBLEPAD Joystick	L3	Pass	Pass	Pass	Pass	Pass	Pass	Pass	Pass	Pass	Pass		1. Install driver and check device manager. No yellow ban"!". 2. Install the game Microsoft Fight Simulator . 3. Use the gamepad to play the game more than 30 minutes. 4. Make sure it can work fine.
i-gota Joystick	L3	Pass	Pass	Pass	Pass	Pass	Pass	Pass	Pass	Pass	Pass		
Flash Fire SF-7301V Joystick	L3	Pass	Pass	Pass	Pass	Pass	Pass	Pass	Pass	Pass	Pass		
Camera													
Logitech QuickCam E3500	L1	Pass	Pass	Pass	Pass	Pass	Pass	Pass	Pass	Pass	Pass		1. Check no yellow ban in device manager after plugging in. 2. Open movie maker, record.
Logitech QuickCam Cool	L1	Pass	Pass	Pass	Pass	Pass	Pass	Pass	Pass	Pass	Pass		
Logitech QuickCam Blue	L1	Pass	Pass	Pass	Pass	Pass	Pass	Pass	Pass	Pass	Pass		
KINYO PCM-531	L1	Pass	Pass	Pass	Pass	Pass	Pass	Pass	Pass	Pass	Pass		
INTOPIC Live Cam 660	L1	Pass	Pass	Pass	Pass	Pass	Pass	Pass	Pass	Pass	Pass		
Card Reader													
SEEHOT CardReader 43 in 1	L2	Pass	Pass	Pass	Pass	Pass	Pass	Pass	Pass	Pass	Pass		1. Check all support card function ok. 2. No any driver letter missed. 3. Copy files from card to c: or from c: to card.
HDD													
SATURNO SATA HDD	L1	Pass	Pass	Pass	Pass	Pass	Pass	Pass	Pass	Pass	Pass		1. No yellow bang in device manager while you plug in. 2. Copy a 100MB file and check no lost.
CUTIE DX eSATA USB2.0	L1	Pass	Pass	Pass	Pass	Pass	Pass	Pass	Pass	Pass	Pass		
ARGOSY HD 530 HDD	L1	Pass	Pass	Pass	Pass	Pass	Pass	Pass	Pass	Pass	Pass		
BD/DVD/CD-RW													
NU External BD Combo	L1	N/A	N/A	N/A	N/A	N/A	N/A	N/A	N/A	N/A	N/A	no support	1. No yellow bang in device manager while you plug in. 2.No driver letter lost in my computer. 3. Play a VCD/DVD or audio CD and no fram drop.
DATA-TEC SATA(NU240S)	L1	N/A	N/A	N/A	N/A	N/A	N/A	N/A	N/A	N/A	N/A	no support	
Sony DRX-S70U	L1	N/A	N/A	N/A	N/A	N/A	N/A	N/A	N/A	N/A	N/A	no support	
Pioneer DVR-X162	L1	N/A	N/A	N/A	N/A	N/A	N/A	N/A	N/A	N/A	N/A	no support	
MSI PM-DS8A/8X	L1	N/A	N/A	N/A	N/A	N/A	N/A	N/A	N/A	N/A	N/A	no support	
Imation HQT	L1	N/A	N/A	N/A	N/A	N/A	N/A	N/A	N/A	N/A	N/A	no support	
Handy Drive													
Handy drive A-date 16G	L1	Pass	Pass	Pass	Pass	Pass	Pass	Pass	Pass	Pass	Pass		1. No yellow bang in device manager while you plug in. 2. Copy a 100MB file and check no lost.
FDD													
FDD Panasonic YD-8U10 USB1.0	L1	Pass	Pass	Pass	Pass	Pass	Pass	Pass	Pass	Pass	Pass		1. Boot from FDD function ok. 2. Open my computer and you can see A: driver letter. 3. Copy a 1MB file and compare the file. No lost. 4. Run DOS
Mitsumi USB1.1 Floppy Disk Drive(QSMC)	L1	N/A	N/A	N/A	N/A	N/A	N/A	N/A	N/A	N/A	N/A	no device	
SMSC USB1.1 external Floppy Drive(QSMC)	L2	N/A	N/A	N/A	N/A	N/A	N/A	N/A	N/A	N/A	N/A	no device	

Test Item	Level	Driver Initial	Graceful Removal	Hot Insert	Surprise Removal	Cold Insert	S3 Removal	S3 Insert	Hibernate Removal	Hibernate Insert	Reboot	Bug NO. / Comment	Expected Result
HUB													
Generic 4-port USB 2.0 HUB	L1	Pass	Pass	Pass	Pass	Pass	Pass	Pass	Pass	Pass	Pass		1. Connect a mouse, printer and keyboard to the HUB and check each devices' function.
TEAC US-4S-20BK 4-Port USB 2.0 HUB	L1	Pass	Pass	Pass	Pass	Pass	Pass	Pass	Pass	Pass	Pass		2. No any yellow bang in device manager. 3. Connect at least three USB 2.0 devices and check function, like HDD and CD-ROM.
Slim DX-274AP USB1.1 SLIM HUB 4 Port(QSMC)	L2	N/A	N/A	N/A	N/A	N/A	N/A	N/A	N/A	N/A	N/A	no device	
3G													
BandLuxe C120 Dongle Modem	L2	N/A	N/A	N/A	N/A	N/A	N/A	N/A	N/A	N/A	N/A	no device	1. Check no yellow bang ^{!!!} in device manager. 2. Connect to Internet and download a 5MB file. 3. Connect to Saturn and download a 100MB file.
TV tuner													
AVerMedia AVerTV Hybrid Volar HX	L1	N/A	N/A	N/A	N/A	N/A	N/A	N/A	N/A	N/A	N/A	no support	1.Plug in TV tuner card. 2.make sure it can works.
Wireless Lan AP													
D-Link DAP-1353(N)	L2	Pass	Pass	Pass	Pass	Pass	Pass	Pass	Pass	Pass	Pass		1. Connect to local network or Internet via Access Point. 2. Follow Lan card test procedure.
BUFFALO WZR-AG300NH(N)	L2	Pass	Pass	Pass	Pass	Pass	Pass	Pass	Pass	Pass	Pass		
Corega CG-WLBARN80(N)	L2	Pass	Pass	Pass	Pass	Pass	Pass	Pass	Pass	Pass	Pass		
Bluetooth													
Bluetooth Mouse													
Bluetooth Mouse (Ferrari 5000)	L1	Pass	Pass	Pass	Pass	Pass	Pass	Pass	Pass	Pass	Pass		1.Connect then check function
Bluetooth Mouse (Ferrari 1000)	L1	Pass	Pass	Pass	Pass	Pass	Pass	Pass	Pass	Pass	Pass		
USB Bluetooth													
Ambeon Bluetooth USB Adapter	L1	Pass	Pass	Pass	Pass	Pass	Pass	Pass	Pass	Pass	Pass		1.Connect then check function
i-Tech BlueCON U2	L1	Pass	Pass	Pass	Pass	Pass	Pass	Pass	Pass	Pass	Pass		
ESENSE Bluetooth USB Adapter	L1	Pass	Pass	Pass	Pass	Pass	Pass	Pass	Pass	Pass	Pass		
Bluetooth PDA													
Glofish X600	L1	Pass	Pass	Pass	Pass	Pass	Pass	Pass	Pass	Pass	Pass		1.Connect then check function
Bluetooth headphone													
Nokia Bluetooth Headphone HS-26W	L1	Fail	Fail	Fail	Fail	Fail	Fail	Fail	Fail	Fail	Fail	see No. 0933-0	1.Connect then check function
Nokia Bluetooth Headphone BH-703	L1	Fail	Fail	Fail	Fail	Fail	Fail	Fail	Fail	Fail	Fail	see No. 0933-0	
Sony Ericsson Headset HBH-DS980	L1	Fail	Fail	Fail	Fail	Fail	Fail	Fail	Fail	Fail	Fail	see No. 0933-0	
Card Reader													
MMC Card													
Transcend MMC 1GB	L1	Pass	Pass	Pass	Pass	Pass	Pass	Pass	Pass	Pass	Pass		1. Insert MMC Card. Should be a driver letter pop up in my computer.
Transcend MMC 2GB	L1	Pass	Pass	Pass	Pass	Pass	Pass	Pass	Pass	Pass	Pass		
SDHC Card													
Transcend SDHC 8GB	L1	Pass	Pass	Pass	Pass	Pass	Pass	Pass	Pass	Pass	Pass		1. Insert SDHC Card. Should be a driver letter pop up in my computer.
Transcend SDHC 16GB	L1	Pass	Pass	Pass	Pass	Pass	Pass	Pass	Pass	Pass	Pass		2. Check the capacitor of the SD Card. If you are using 128MB SD card, please try to copy 100MB files to SD card.
Toshiba SDHC 4GB	L1	Pass	Pass	Pass	Pass	Pass	Pass	Pass	Pass	Pass	Pass		3. Insert/remove card several times and then check if system can detect correctly.
ADATA SDHC 16GB	L1	Pass	Pass	Pass	Pass	Pass	Pass	Pass	Pass	Pass	Pass		
SanDisk SDHC 8GB	L1	Pass	Pass	Pass	Pass	Pass	Pass	Pass	Pass	Pass	Pass		
SD Adapter													
SanDisk microSD(8GB) Adapter	L1	Pass	Pass	Pass	Pass	Pass	Pass	Pass	Pass	Pass	Pass		Test with SD card
SanDisk SD Adapter	L1	Pass	Pass	Pass	Pass	Pass	Pass	Pass	Pass	Pass	Pass		
MS Card													
SanDisk 64MB MS Card(QSMC)	L1	Pass	Pass	Pass	Pass	Pass	Pass	Pass	Pass	Pass	Pass		1. Insert MS Card. Should be a driver letter pop up in my computer.
MS Pro Card													
LEXAR 256MB MS Card (MS Pro)(QSMC)	L2	Pass	Pass	Pass	Pass	Pass	Pass	Pass	Pass	Pass	Pass		1. Insert MS Card. Should be a driver letter pop up in my computer.
MS Pro Duo Card													
Sony MS PRO Duo 4GB	L1	Pass	Pass	Pass	Pass	Pass	Pass	Pass	Pass	Pass	Pass		1. Insert MS Card. Should be a driver letter pop up in my computer.
SanDisk MS PRO Duo 4GB	L1	Pass	Pass	Pass	Pass	Pass	Pass	Pass	Pass	Pass	Pass		
SanDisk MS PRO Duo 8GB	L1	Pass	Pass	Pass	Pass	Pass	Pass	Pass	Pass	Pass	Pass		
MS Duo Adapter													
Sony MS Duo Adapter	L1	Pass	Pass	Pass	Pass	Pass	Pass	Pass	Pass	Pass	Pass		Test with MS Pro duo card
SanDisk MS Duo Adapter	L1	Pass	Pass	Pass	Pass	Pass	Pass	Pass	Pass	Pass	Pass		
MicroSD													
SanDisk microSD 8G	L1	Pass	Pass	Pass	Pass	Pass	Pass	Pass	Pass	Pass	Pass		Test with MicroSD to MicroSD to MS Pro Duo Adapter + MS Duo Adapter
MicroSD to MS Pro Duo Adapter													
Transcend microSD(2GB) to MS PRO Duo Adapter	L1	Pass	Pass	Pass	Pass	Pass	Pass	Pass	Pass	Pass	Pass		Test with MicroSD card + MS Duo Adapter

Test Item	Level	Driver Initial	Graceful Removal	Hot Insert	Surprise Removal	Cold Insert	S3 Removal	S3 Insert	Hibernate Removal	Hibernate Insert	Reboot	Bug NO. / Comment	Expected Result
XD Card													
FUJIFILM XD M-Type 1GB	L1	Pass	Pass	Pass	Pass	Pass	Pass	Pass	Pass	Pass	Pass		1. Insert XD Card. Should be a driver letter pop up in my
FUJIFILM XD H-Type 1GB	L1	Pass	Pass	Pass	Pass	Pass	Pass	Pass	Pass	Pass	Pass		
FUJIFILM XD M-Type 2GB	L1	Pass	Pass	Pass	Pass	Pass	Pass	Pass	Pass	Pass	Pass		
FUJIFILM XD H-Type 2GB	L1	Pass	Pass	Pass	Pass	Pass	Pass	Pass	Pass	Pass	Pass		
OLYMPUS XD M+ 2GB	L1	Pass	Pass	Pass	Pass	Pass	Pass	Pass	Pass	Pass	Pass		
1394 Port													
1394-HDD													
Clearlight 2.5" Hard Drive Enclosure(40G)(OSMC)	L1	N/A	N/A	N/A	N/A	N/A	N/A	N/A	N/A	N/A	N/A	no support	1. No yellow bang in device manager after you plug in.
UNIQUE UA351-CB USB2.0/1394 HDD	L1	N/A	N/A	N/A	N/A	N/A	N/A	N/A	N/A	N/A	N/A	no support	
1394-Cable													
1394 Pear To Pear Cable	L1	N/A	N/A	N/A	N/A	N/A	N/A	N/A	N/A	N/A	N/A	no support	1. Connect two computer via 1394 cable. 2. You can see two computs in 1394 network. 3. Share a folder from unit 1. 4. Transfer files from unit 1 to unit 2 and
Audio Jacks Port													
Speaker													
Creative Inspire 5.1 digital 5600	L1	Pass	Pass	Pass	Pass	Pass	Pass	Pass	Pass	Pass	Pass		1. Play audio, audio output should auto switch to speaker. 2. Check audio quality, no delay. 3. Check left & right channel.
J-S J1116A Speaker	L1	N/A	N/A	N/A	N/A	N/A	N/A	N/A	N/A	N/A	N/A	Device break	
Beauty Jazz Speaker	L1	N/A	N/A	N/A	N/A	N/A	N/A	N/A	N/A	N/A	N/A	Device break	
Head Phone													
Philips Headphone SBC HP090	L1	Pass	Pass	Pass	Pass	Pass	Pass	Pass	Pass	Pass	Pass		1. Play audio, audio output should auto switch to headphone. 2. Check audio quality, no delay. 3. Check left & right channel.
MONARCH POWER STEREO HEADPHONES MO-J39	L1	Pass	Pass	Pass	Pass	Pass	Pass	Pass	Pass	Pass	Pass		
INTOPIC JAZZ-369 Headphones	L1	Pass	Pass	Pass	Pass	Pass	Pass	Pass	Pass	Pass	Pass		
Microphone													
Victor MC-D01 Microphone	L1	Pass	Pass	Pass	Pass	Pass	Pass	Pass	Pass	Pass	Pass		
Vio-EP2100 Microphone	L1	N/A	N/A	N/A	N/A	N/A	N/A	N/A	N/A	N/A	N/A	Device break	
SPDIF													
Creative Inspire 5.1 digital 5600	L1	Pass	Pass	Pass	Pass	Pass	Pass	Pass	Pass	Pass	Pass		1. Play audio, audio output should auto switch to headphone.
Docking													
Cable Docking	L1	N/A	N/A	N/A	N/A	N/A	N/A	N/A	N/A	N/A	N/A	no support	Follow Docking test case
PC Game													
Company of Heroes	L1	Pass										will lag	1. Follow the install instruction. Make sure the game can
Microsoft Flight Simulator X Deluxe Razor 1911	L1	Pass											
Eidos -Tomb Raider	L1	Pass											
Supreme Commander	L1	Pass											
Command & Conquer 3 Tiberium Wars	L1	N/A										Don't support	
Unreal Tournament 3 (2007)	L2	Pass										Don't support	
QUAKE 4	L3	Pass											
Crysis	L3	N/A											
Enemy Territory - Quake Wars	L1	Pass											
World in Conflict	L1	Pass											
Tomb Raider Anniversary	L1	Pass											
Call of Duty 4	L1	Pass											
Far Cry 2	L1	Pass										will lag	
WarhammerR 40,000 Dawn of WarR II	L1	Pass											
On Line Game													
Lineage II: The Chaotic Throne - Gracia [凯赫-特勒西亚]	L1	N/A	N/A	N/A	N/A	N/A	N/A	N/A	N/A	N/A	N/A	no support	1. Follow the install instruction. Make sure the game can
World Of Warcraft - Wrath of the Lich King [巫妖王之怒]	L1	Pass											

Test Item	Level	Driver Initial	Graceful Removal	Hot Insert	Surprise Removal	Cold Insert	S3 Removal	S3 Insert	Hibernate Removal	Hibernate Insert	Reboot	Bug NO. / Comment	Expected Result
Additional S/W AP													
Microsoft Office2010	L1	Pass											Install the software and check the function works, No err
SPECviewperf 10 or later (OpenGL Tool)	L1	N/A											
Works 9.0 or later	L1	N/A											
Skype 4.0 or later	L1	N/A											
MSN 9.0 or later	L1	N/A											
Yahoo Messenger 9.0 or later	L2	N/A											
VMWare 6.0 or later	L3	N/A											
Blu-Ray													
Bail (H.264 1080i)---Play chapter2 (Made in U.S.A)	L1	N/A	N/A	N/A	N/A	N/A	N/A	N/A	N/A	N/A	N/A	no support	<p>Make sure below function works</p> <ol style="list-style-type: none"> 1. Install/Uninstall Player 2. Region check 3. Check Audio and video Quality at full screen play and normal play at least 30 minutes (every discs), and Blood Diamond must play to end. 4. CPU Usage <80% 5. Frame display and Audio can't lag or auto shut down in AC/DC. 6. No interfere with Game/DVD/HD-DVD/BD/Audio play when peripheral device(Bluetooth...) turn on/off or volume adjust 7. DVD/HD-DVD/BD playback simultaneously,external monitor can't black disapy 8. Resolution must be kept after LCD/CRT switch or resume from S3/S4/Reboot
火車旅行 (H.264 1080i)---Play chapter1 (Made in JPN)	L1	N/A	N/A	N/A	N/A	N/A	N/A	N/A	N/A	N/A	N/A	no support	
Blood Diamond (VC-1 1080P)---Play chapter3 (Made in U.S.A)	L1	N/A	N/A	N/A	N/A	N/A	N/A	N/A	N/A	N/A	N/A	no support	
Spring in JPN (MPEG-2 1080i)---Play chapter3 (Made in JPN)	L1	N/A	N/A	N/A	N/A	N/A	N/A	N/A	N/A	N/A	N/A	no support	
Resident evil3 (H.264 1080P Profile 1.1+PIP)----Play c	L1	N/A	N/A	N/A	N/A	N/A	N/A	N/A	N/A	N/A	N/A	no support	
Saw IV	L1	N/A	N/A	N/A	N/A	N/A	N/A	N/A	N/A	N/A	N/A	no support	
Sunshine	L1	N/A	N/A	N/A	N/A	N/A	N/A	N/A	N/A	N/A	N/A	no support	
War	L1	N/A	N/A	N/A	N/A	N/A	N/A	N/A	N/A	N/A	N/A	no support	
Cars	L1	N/A	N/A	N/A	N/A	N/A	N/A	N/A	N/A	N/A	N/A	no support	
Spider Man 3	L1	N/A	N/A	N/A	N/A	N/A	N/A	N/A	N/A	N/A	N/A	no support	
The Last Stand	L1	N/A	N/A	N/A	N/A	N/A	N/A	N/A	N/A	N/A	N/A	no support	
The Architect	L1	N/A	N/A	N/A	N/A	N/A	N/A	N/A	N/A	N/A	N/A	no support	
Resident Evil : Extinction	L1	N/A	N/A	N/A	N/A	N/A	N/A	N/A	N/A	N/A	N/A	no support	
ILHA Formosa	L1	N/A	N/A	N/A	N/A	N/A	N/A	N/A	N/A	N/A	N/A	no support	

Online Support Information

This section describes online technical support services available to help you repair your Acer Systems.

If you are a distributor, dealer, ASP or TPM, please refer your technical queries to your local Acer branch office. Acer Branch Offices and Regional Business Units may access our website. However some information sources will require a user i.d. and password. These can be obtained directly from Acer CSD Taiwan.

Acer's Website offers you convenient and valuable support resources whenever you need them.

In the Technical Information section you can download information on all of Acer's Notebook, Desktop and Server models including:

- Service guides for all models
- User's manuals
- Training materials
- Bios updates
- Software utilities
- Spare parts lists
- TABs (Technical Announcement Bulletin)

For these purposes, we have included an Acrobat File to facilitate the problem-free downloading of our technical material.

Also contained on this website are:

- Detailed information on Acer's International Traveler's Warranty (ITW)
- Returned material authorization procedures
- An overview of all the support services we offer, accompanied by a list of telephone, fax and email contacts for all your technical queries.

We are always looking for ways to optimize and improve our services, so if you have any suggestions or comments, please do not hesitate to communicate these to us.

A

- Antennas
 - Removing 94, 97

B

- Battery Pack
 - Removing 42
- BIOS
 - ROM type 17
 - vendor 17
 - Version 17
- BIOS Utility 23–31
 - Advanced 26
 - Boot 29
 - Exit 30
 - Navigating 23
 - Save and Exit 30
 - Security 26
 - System Security 30
- Bluetooth Module
 - Removing 121
- brightness
 - hotkeys 12
- Button Board
 - Removing 61

C

- Camera Board
 - Removing 85, 106
- caps lock
 - on indicator 8
- Common Problems 144
- CRT Cable
 - Removing 115

D

- DIMM Module
 - Removing 47
- Display 3
- display
 - hotkeys 12

E

- Euro Key 13

- External Module Disassembly
 - Flowchart 41

F

- Features 1
- FLASH Utility 31
- Flash Utility 31
- FRU (Field Replaceable Unit) List 169

H

- Hard Disk Drive Module
 - Removing 45
- Hibernation mode
 - hotkey 12
- Hot Keys 10

I

- Indicators 8
- Intermittent Problems 154
- Internal Microphone Failure 151
- Internal Speaker Failure 150

J

- Jumper and Connector Locations 165

K

- Keyboard
 - Removing 53
- Keyboard Failure 148

L

- LCD Bezel
 - Removing 82, 107
- LCD Brackets
 - Removing 88, 101
- LCD Cable
 - Removing 88, 101
- LCD Failure 147
- LCD Module
 - Removing 110
- LCD Module Disassembly
 - Flowchart 80

LCD Panel
Removing 86, 103

M

Main Unit Disassembly
Flowchart 51

Mainboard
Removing 115

media access
on indicator 8

Memory Check 144

Microphone
Removing 86, 103

Model Definition 177

N

No Display Issue 145

num lock
on indicator 8

O

ODD Failure 153

Online Support Information 199

P

Panel 4
left 4

PC Card 8

Power On Failure 144

S

Speaker Module
Removing 77

speakers
hotkey 12

System
Block Diagram 3

T

Test Compatible Components 191

Thermal Module
Removing 76, 112

Touch Pad Failure 149

Troubleshooting
Built-in KB Failure 148

Internal Microphone 151
Internal Speakers 150
LCD Failure 147
No Display 145
ODD 153
Other Failures 153
Power On 144
Touch Pad 149
USB 153

U

Undetermined Problems 154

Upper Cover
Removing 57

USB Failure (Rightside) 153

utility
BIOS 23–31

V

volume
hotkeys 12

W

Windows 2000 Environment Test 191

WLAN Board
Removing 48

